

Controlled Document
Confirm revision before using

ACC24 JMACH1 CABLE

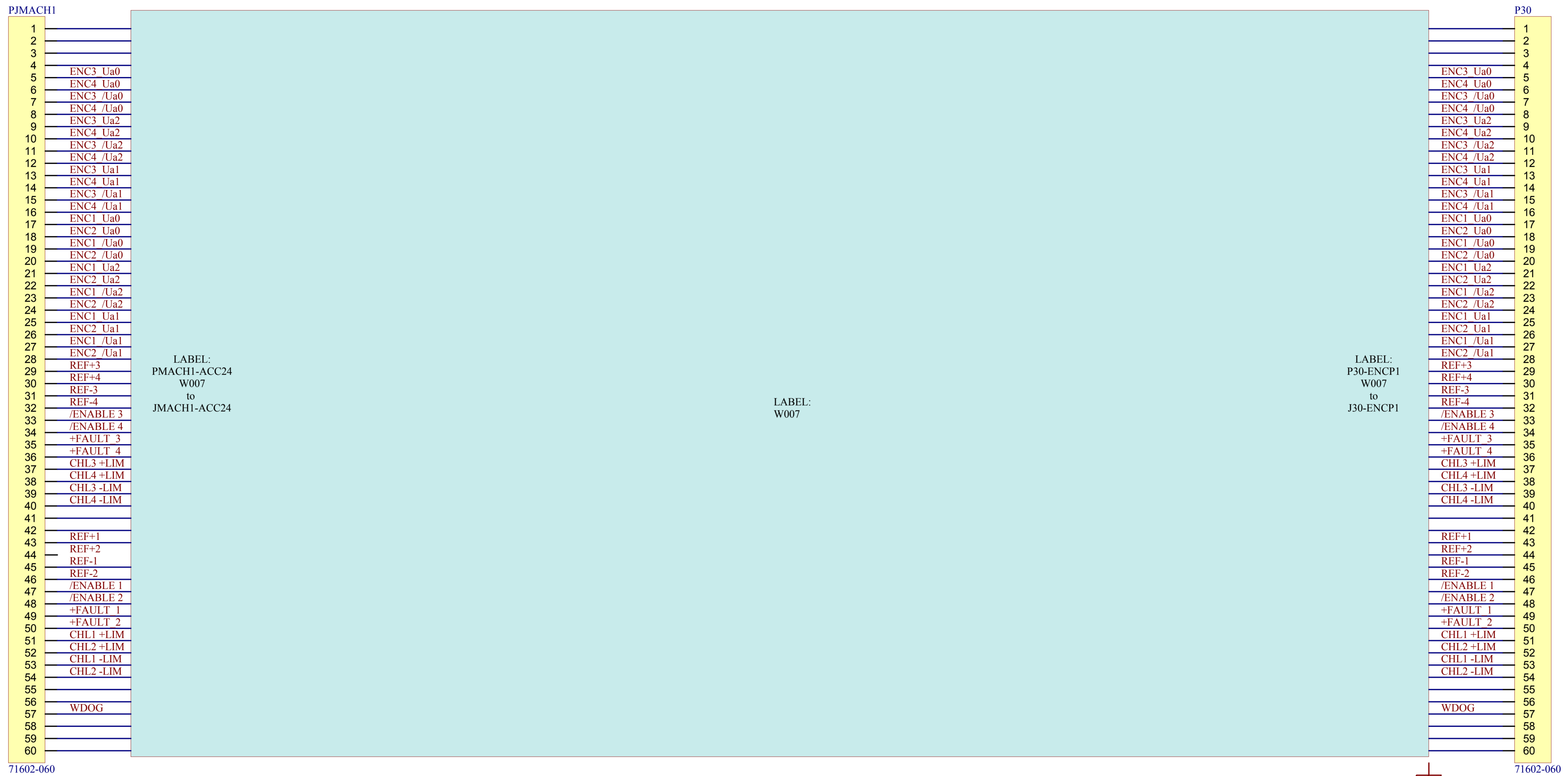

WIRE TYPE:843-159-2801-060 Shielded ribbon cable
LENGTHS: ACC24: 26"

© 2005 EOS Technologies, Inc.
Tucson, AZ USA

THIS DOCUMENT & ENCLOSED INFORMATION
REMAINS THE PROPERTY OF EOS
TECHNOLOGIES INC. INTELLECTUAL
PROPERTY AND INFORMATION HEREIN MAY
NOT BE COPIED NOR DISCLOSED WITHOUT
WRITTEN CONSENT OF EOS TECHNOLOGIES,
INC. MANAGEMENT.

FILE C:\GGay\Lick Schematics\SCH-5376-4 APF Cabinet Cable Schematics TEMP\acc24jmach1W007.SCHDOC
PRINTED 12/8/2009 4:07:12 PM
TEMPLATE: Eost_tabloid_SUBS

EOS Technologies, Inc.

3160 E. TRANSCON WAY, Suite 180
TUCSON, ARIZONA 85706 USA

TITLE

LICK APF ACC24 MACH1 to ENCP1 Interface

DOCUMENT NUMBER

SCH-5376-4

SIZE

A3

EastConfig

SCH-5376-4

SHEET 20

OF

64

SCH-5376-4-ICK APF ACC24 MACH1 to ENCP1 Interface

Controlled Document
Confirm revision before using

ACC24 JMACH2 CABLE

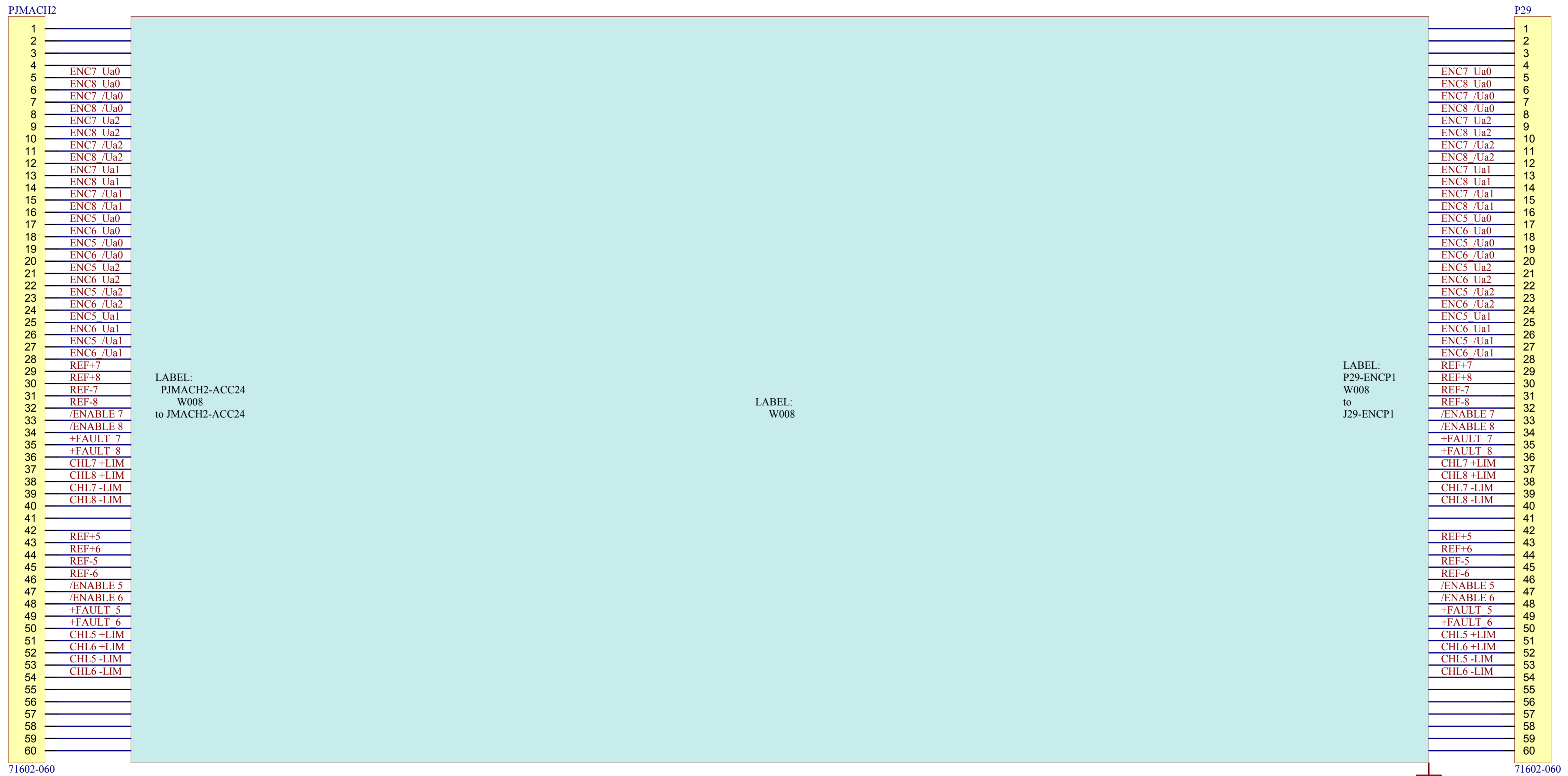

WIRE TYPE:843-159-2801-060 Shielded ribbon cable
LENGTHS: ACC24: 35"

© 2005 EOS Technologies, Inc.
Tucson, AZ USA

THIS DOCUMENT & ENCLOSED INFORMATION
REMAINS THE PROPERTY OF EOS
TECHNOLOGIES INC. INTELLECTUAL
PROPERTY AND INFORMATION HEREIN MAY
NOT BE COPIED NOR DISCLOSED WITHOUT
WRITTEN CONSENT OF EOS TECHNOLOGIES,
INC. MANAGEMENT.

FILE C:\GGay\Lick Schematics\SCH-5376-4 APF Cabinet Cable Schematics TEMP\acc24jmach2W008.SCHDOC
PRINTED 12/8/2009 4:07:13 PM
TEMPLATE: Eost_tabloid_SUBS

EOS Technologies, Inc.

3160 E. TRANSCON WAY, Suite 180
TUCSON, ARIZONA 85706 USA

TITLE

LICK APF ACC24 MACH2 to ENCP1 Interface

DOCUMENT NUMBER

SCH-5376-4

SIZE

A3

EastConfig

SCH-5376-4

SHEET 21

OF

64

SCH-5376-4 LICK APF ACC24 MACH2 to ENCP1 Interface

ENCODER PLANAR

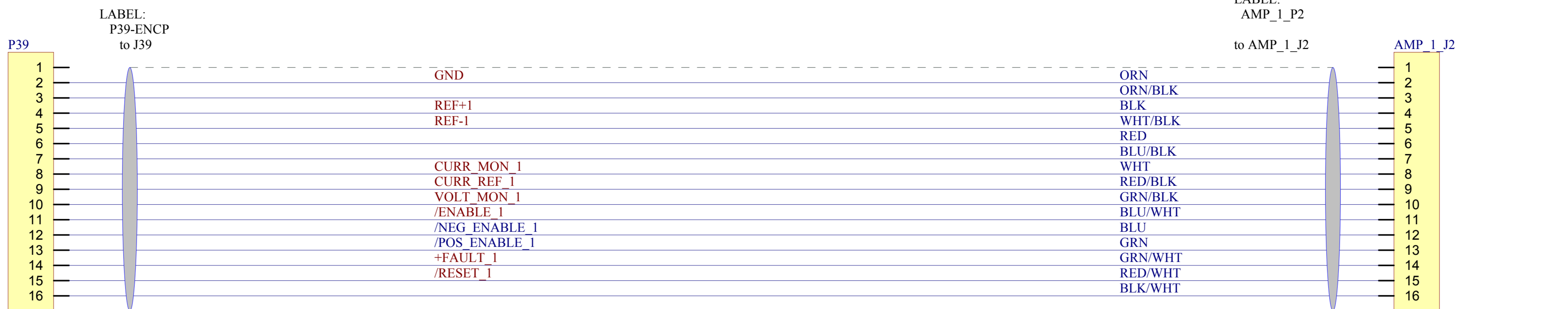

22-01-3167 w/08-50-0114 pins

22-01-3167 w/ 08-50-0114 pins

ENCODER PLANAR



22-01-3167 w/08-50-0114 pins

22-01-3167 w/ 08-50-0114 pins

ENCODER PLANAR



22-01-3167 w/08-50-0114 pins

22-01-3167 w/ 08-50-0114 pins

ENCODER PLANAR



22-01-3167 w/08-50-0114 pins

22-01-3167 w/ 08-50-0114 pins

WIRE TYPE: Belden 9616

© 2005 EOS Technologies, Inc.
Tucson, AZ USA

THIS DOCUMENT & ENCLOSED INFORMATION
REMAINS THE PROPERTY OF EOS
TECHNOLOGIES INC. INTELLECTUAL
PROPERTY AND INFORMATION HEREIN MAY
NOT BE COPIED NOR DISCLOSED WITHOUT
WRITTEN CONSENT OF EOS TECHNOLOGIES,
INC. MANAGEMENT.

FILE C:\GGay\Lick Schematics\SCH-5376-4 APF Cabinet Cable Schematics TEMPAMP_WIRING.SCHDOC
PRINTED 12/8/2009 4:07:13 PM
TEMPLATE: Eost_tabloid_SUBS

EOS Technologies, Inc.

3160 E. TRANSCON WAY, Suite 180
TUCSON, ARIZONA 85706 USA

TITLE

LICK APF ENCP0 Amplifier Interface

DOCUMENT NUMBER

SCH-5376-4

SIZE

A3

EastConfig SCH-5376-4

SHEET 6 OF 64

ENCODER PLANAR
AZIMUTH

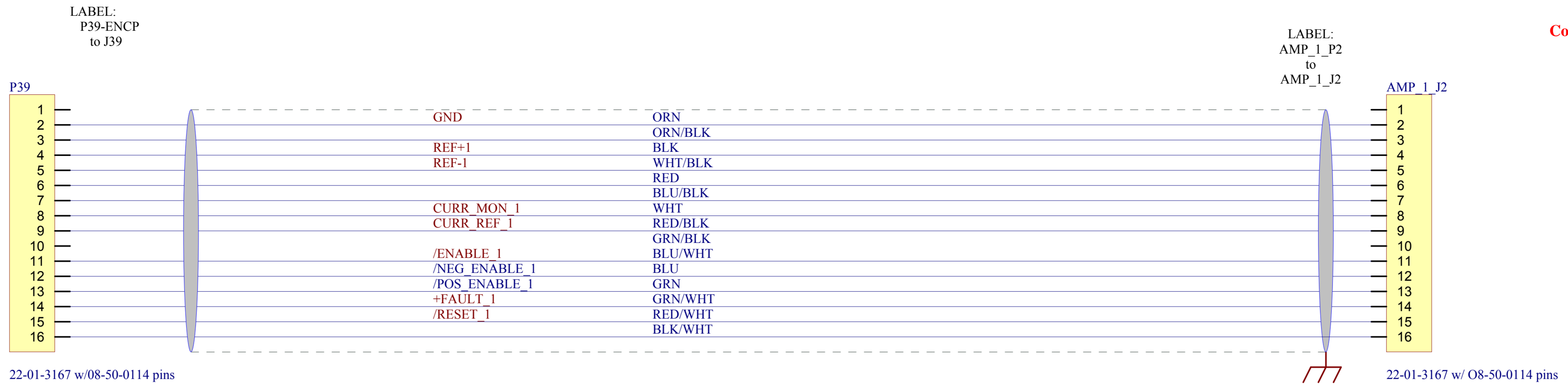

ENCODER PLANAR
ELEVATION

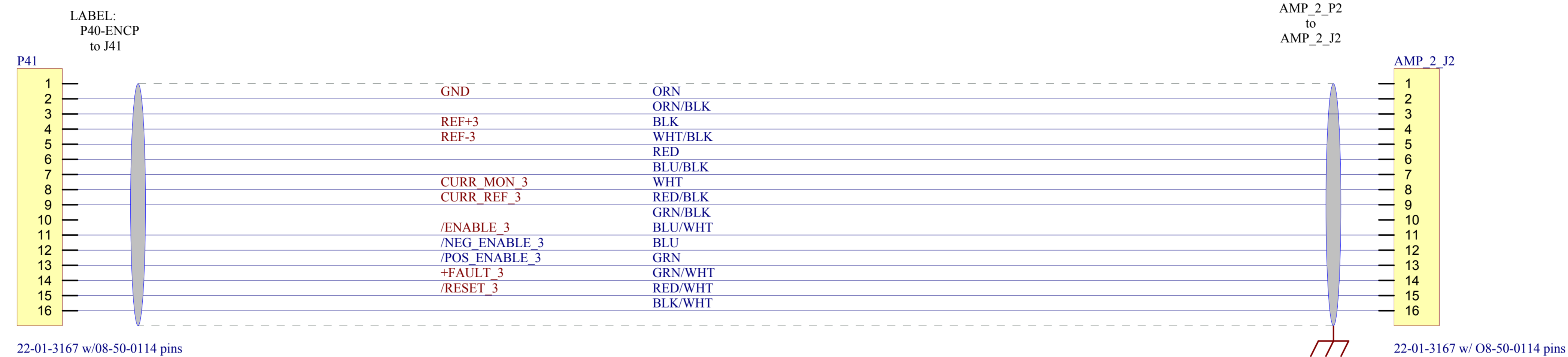

ENCODER PLANAR
INSTRUMENT ROTATOR (Option)

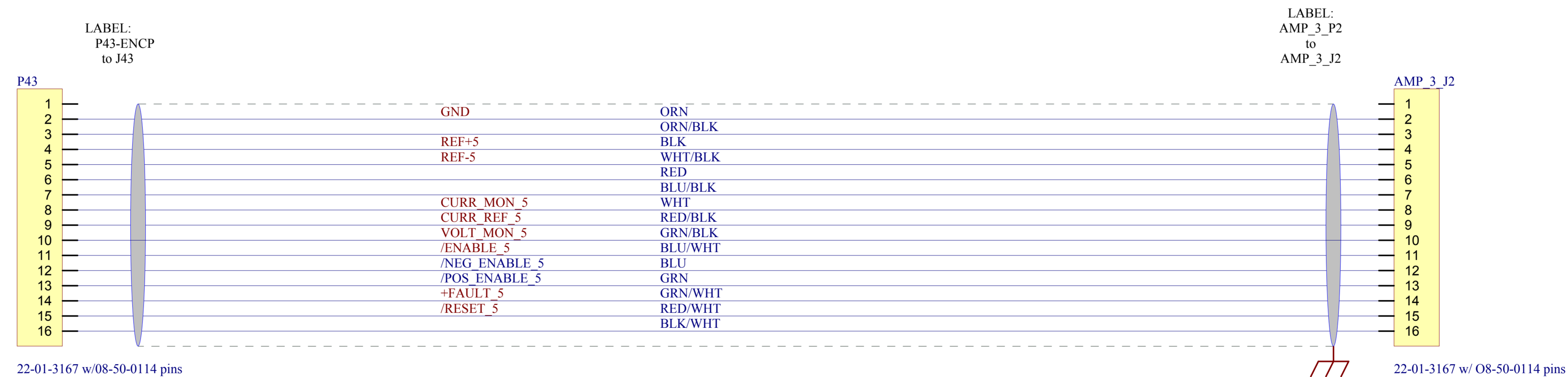

WIRE TYPE: Belden 9616

© 2005 EOS Technologies, Inc.
Tucson, AZ USA

THIS DOCUMENT & ENCLOSED INFORMATION
REMAINS THE PROPERTY OF EOS
TECHNOLOGIES INC. INTELLECTUAL
PROPERTY AND INFORMATION HEREIN MAY
NOT BE COPIED NOR DISCLOSED WITHOUT
WRITTEN CONSENT OF EOS TECHNOLOGIES,
INC. MANAGEMENT.

FILE C:\GGay\Lick Schematics\SCH-5376-4 APF Cabinet Cable Schematics TEMPAMP_WIRING_1.SCHDOC
PRINTED 12/8/2009 4:07:14 PM
TEMPLATE: Eost_tabloid_SUBS

EOS Technologies, Inc.

3160 E. TRANSCON WAY, Suite 180
TUCSON, ARIZONA 85706 USA

TITLE

LICK APF ENCP1 Amplifier Interface

DOCUMENT NUMBER

SCH-5376-4

SIZE

A3

EastConfig

SCH-5376-4

SHEET 10

OF

64

Label:
P15_DIOP
W056
to J15_DIOP
CARD

Label:
W056

Label:
CJ12
W056
to CAB_PNL

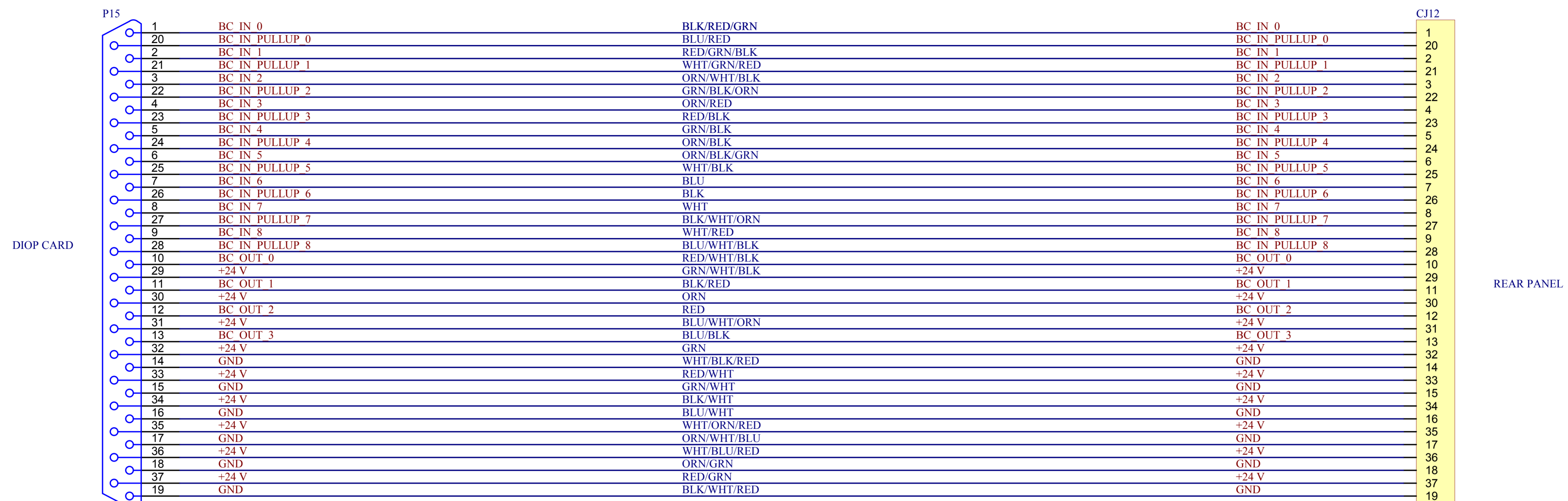

205168-1
B.S. 748677-4

206438-1
B.S. 207774-1

WIRE TYPE: ALPHA 6349
LENGTH: 58"

MIRROR COVER CONTROL I/O

KEY: PIN 56

© 2005 EOS Technologies, Inc.
Tucson, AZ USA

THIS DOCUMENT & ENCLOSED INFORMATION
REMAINS THE PROPERTY OF EOS
TECHNOLOGIES INC. INTELLECTUAL
PROPERTY AND INFORMATION HEREIN MAY
NOT BE COPIED NOR DISCLOSED WITHOUT
WRITTEN CONSENT OF EOS TECHNOLOGIES,
INC. MANAGEMENT.

FILE C:\GGay\Lick Schematics\SCH-5376-4 APF Cabinet Cable Schematics TEMP\APFmc_interfaceW056.SCHDOC
PRINTED 12/8/2009 4:07:15 PM
TEMPLATE: Eost_tabloid_SUBS

EOS Technologies, Inc.
3160 E. TRANSCON WAY, Suite 180
TUCSON, ARIZONA 85706 USA

TITLE
APF Mirror Cover Control Interface

DOCUMENT NUMBER
SCH-5376-4

SIZE
A3

EastConfig SCH-5376-4 SHEET 55 OF 64

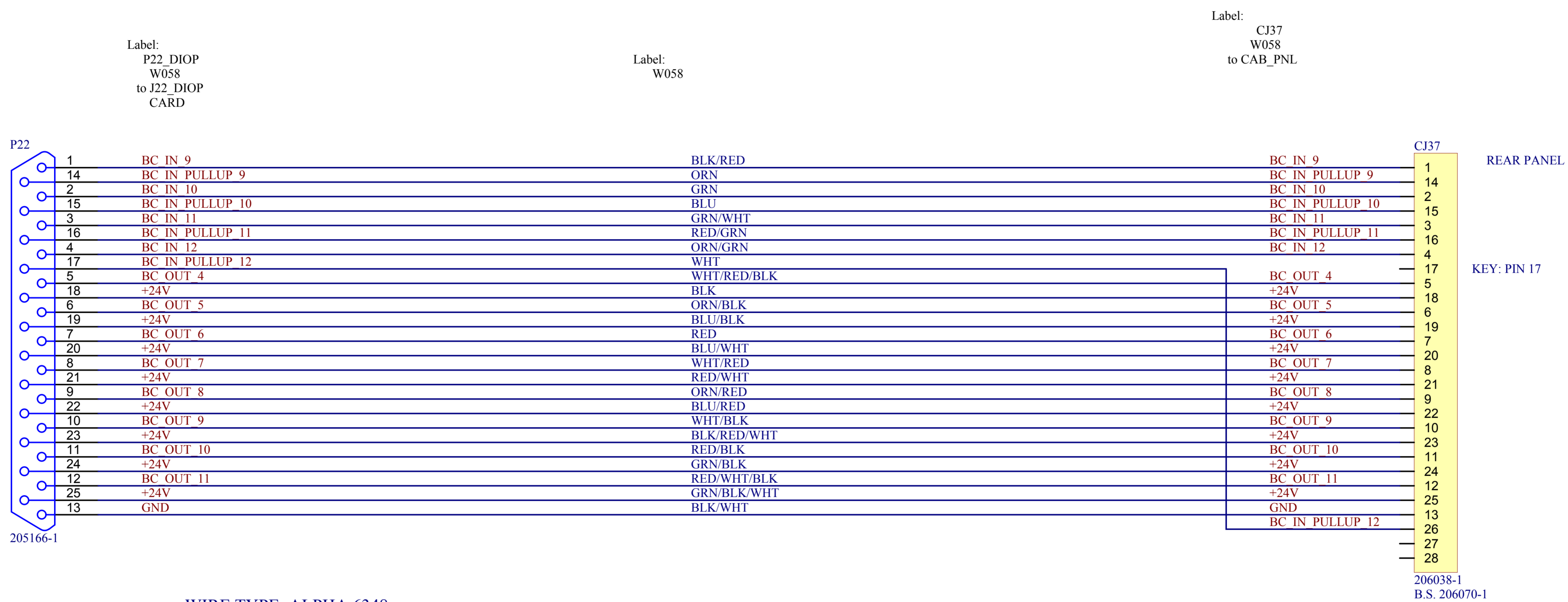

WIRE TYPE: ALPHA 6348
LENGTH: 48"

© 2005 EOS Technologies, Inc.
Tucson, AZ USA

THIS DOCUMENT & ENCLOSED INFORMATION
REMAINS THE PROPERTY OF EOS
TECHNOLOGIES INC. INTELLECTUAL
PROPERTY AND INFORMATION HEREIN MAY
NOT BE COPIED NOR DISCLOSED WITHOUT
WRITTEN CONSENT OF EOS TECHNOLOGIES,
INC. MANAGEMENT.

FILE C:\GGay\Lick Schematics\SCH-5376-4 APF Cabinet Cable Schematics TEMP\APFmc_paddleW058.SCHDOC
PRINTED 12/8/2009 4:07:16 PM
TEMPLATE: Eost_tabloid_SUBS

EOS Technologies, Inc.

3160 E. TRANSCON WAY, Suite 180
TUCSON, ARIZONA 85706 USA

TITLE

APF Mirror Cover Hand Paddle Cable

DOCUMENT NUMBER

SCH-5376-4

SIZE

A3

EastConfig

SCH-5376-4

SHEET 56

OF

64

M1 MIRROR COVER POWER

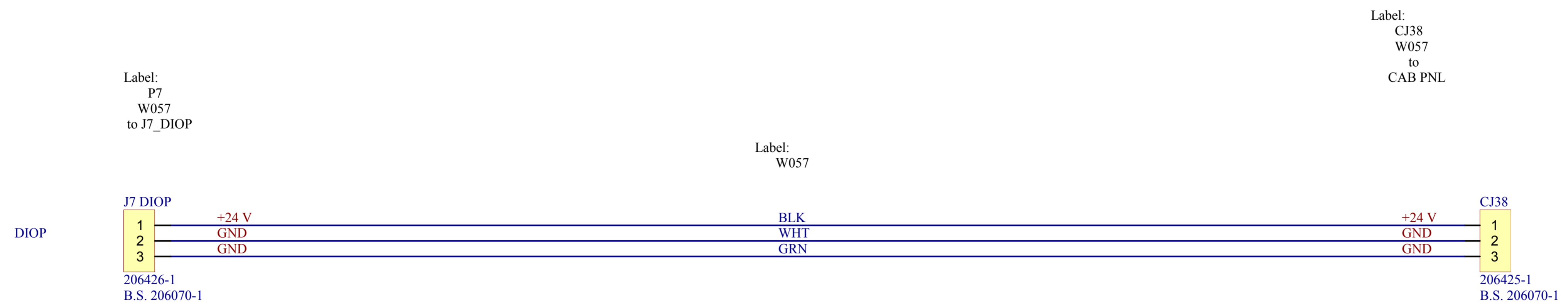

WIRE TYPE: BELDEN P-136-49-MSHA
LENGTH: 72"

© 2005 EOS Technologies, Inc.
Tucson, AZ USA

THIS DOCUMENT & ENCLOSED INFORMATION
REMAINS THE PROPERTY OF EOS
TECHNOLOGIES INC. INTELLECTUAL
PROPERTY AND INFORMATION HEREIN MAY
NOT BE COPIED NOR DISCLOSED WITHOUT
WRITTEN CONSENT OF EOS TECHNOLOGIES,
INC. MANAGEMENT.

FILE C:\GGay\Lick Schematics\SCH-5376-4 APF Cabinet Cable Schematics TEMP\APFmc_powerW057.SCHDOC
PRINTED 12/8/2009 4:07:17 PM
TEMPLATE: Eost_tabloid_SUBS

EOS Technologies, Inc.

3160 E. TRANSCON WAY, Suite 180
TUCSON, ARIZONA 85706 USA

TITLE

APF Mirror Cover Power

DOCUMENT NUMBER

SCH-5376-4

SIZE

A3

EastConfig

SCH-5376-4

SHEET 57 OF

64

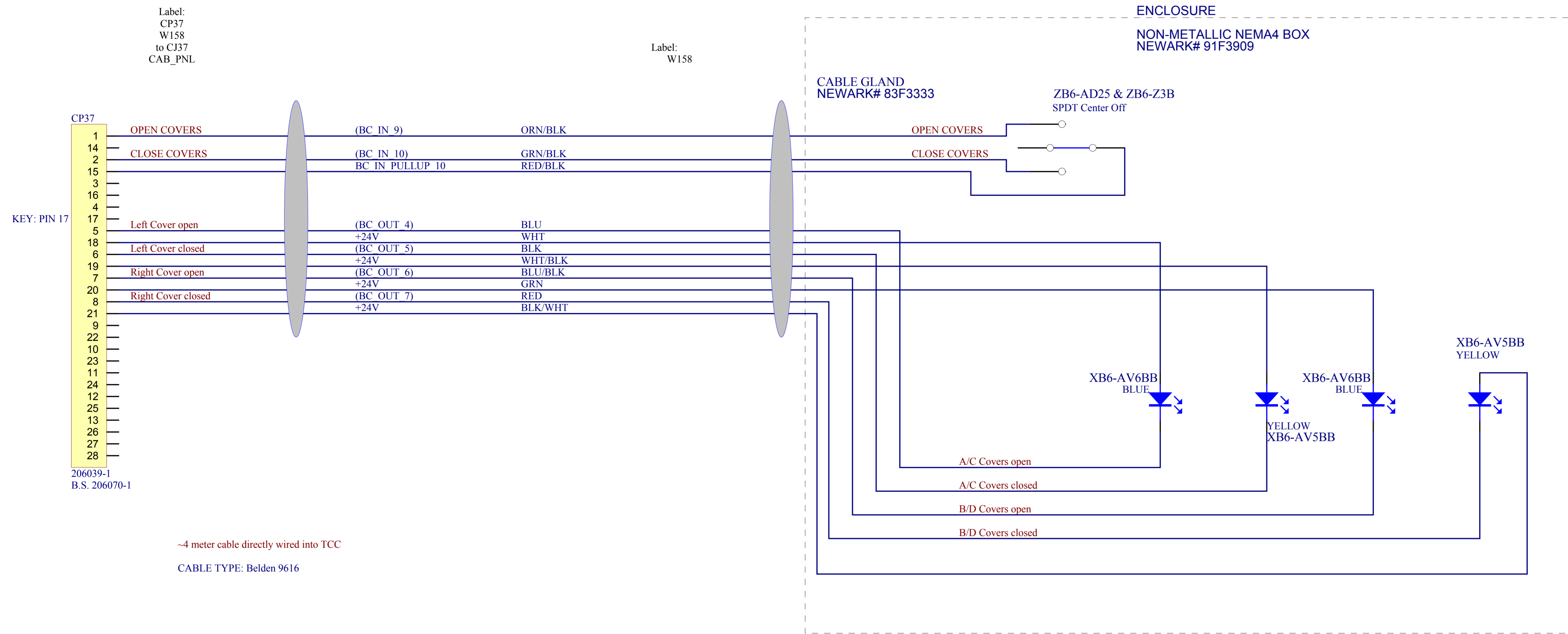

CP37
1
14
2
15
3
16
4
17
5
18
6
19
7
20
8
21
9
22
10
23
11
24
12
25
13
26
14
27
15
28

KEY: PIN 17

206039-1
B.S. 206070-1

Label:
CP37
W158
to CJ37
CAB_PNL

Label:
W158

ENCLOSURE
NON-METALLIC NEMA4 BOX
NEWARK# 91F3909

CABLE GLAND
NEWARK# 83F3333

ZB6-AD25 & ZB6-Z3B
SPDT Center Off

XB6-AV6BB
BLUE

XB6-AV6BB
BLUE

XB6-AV5BB
YELLOW

A/C Covers open

A/C Covers closed

B/D Covers open

B/D Covers closed

~4 meter cable directly wired into TCC

CABLE TYPE: Belden 9616

© 2005 EOS Technologies, Inc.
Tucson, AZ USA

THIS DOCUMENT & ENCLOSED INFORMATION
REMAINS THE PROPERTY OF EOS
TECHNOLOGIES INC. INTELLECTUAL
PROPERTY AND INFORMATION HEREIN MAY
NOT BE COPIED NOR DISCLOSED WITHOUT
WRITTEN CONSENT OF EOS TECHNOLOGIES,
INC. MANAGEMENT.

FILE C:\GGay\Lick Schematics\SCH-5376-4 APF Cabinet Cable Schematics TEMP\APFMirror_cover_paddle.SCHDOC
PRINTED 12/8/2009 4:07:18 PM
TEMPLATE: Eost_tabloid_SUBS

EOS Technologies, Inc.

3160 E. TRANSCON WAY, Suite 180
TUCSON, ARIZONA 85706 USA

TITLE

APF Mirror Cover Hand Paddle Assembly

DOCUMENT NUMBER

SCH-5376-4

SIZE

A3

EastConfig

SCH-5376-4

SHEET 58

OF 64

Controlled Document
Confirm revision before using

ISSUE	DATE	DESCRIPTION	CHECKED	APPROVED
1	04/19/2004	INITIAL RELEASE	KRH	BC
2	05/05/2005	ECO-0288	KRH	JRE
3	06/02/2005	ECO-0335	CLH	KRH
4	12/08/09	ECO-0716		

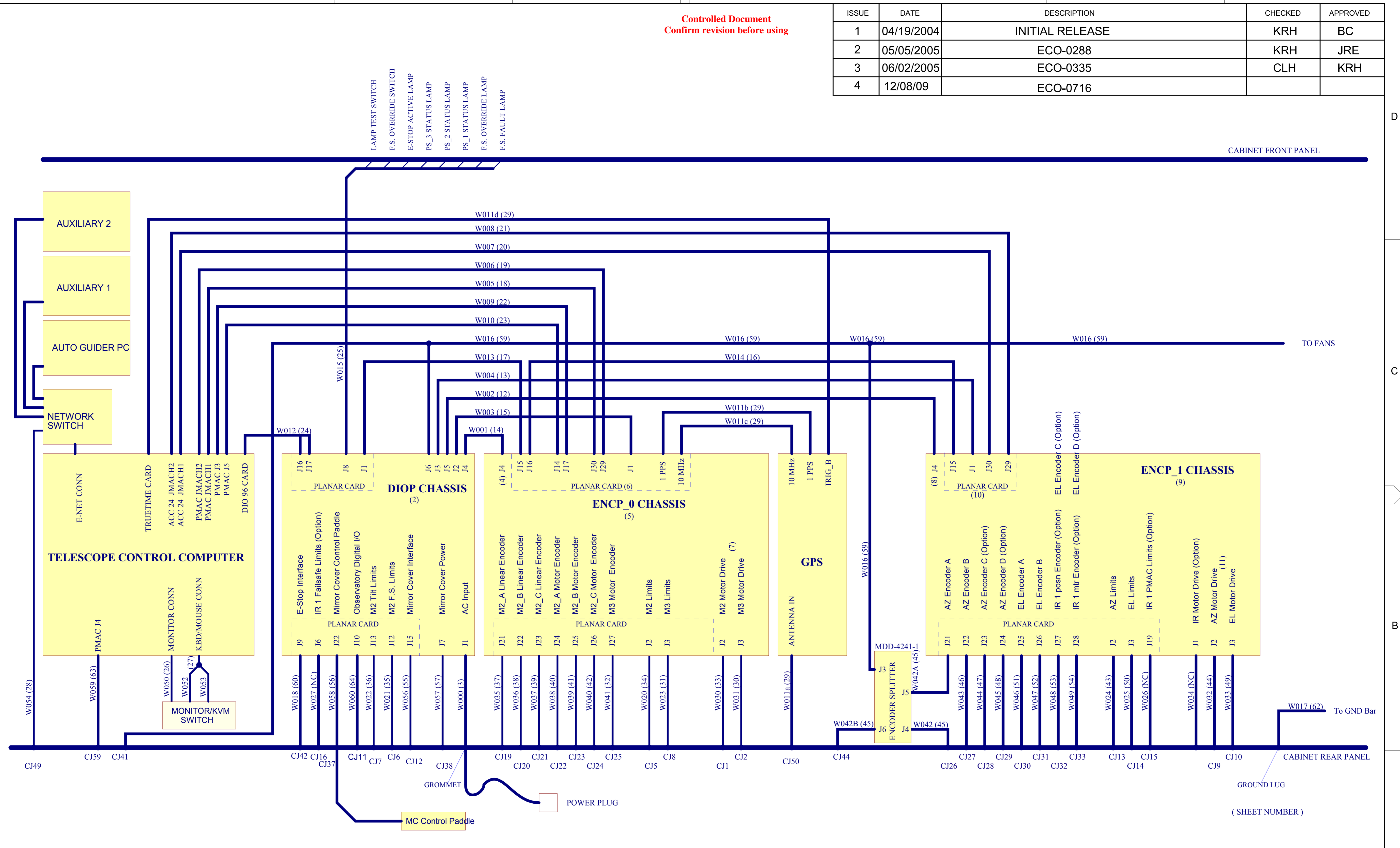

© 2005 EOS Technologies, Inc.
Tucson, AZ USA

THIS DOCUMENT & ENCLOSED INFORMATION REMAINS THE PROPERTY OF EOS TECHNOLOGIES INC. INTELLECTUAL PROPERTY AND INFORMATION HEREIN MAY NOT BE COPIED NOR DISCLOSED WITHOUT WRITTEN CONSENT OF EOS TECHNOLOGIES, INC. MANAGEMENT.

DESIGN	DATE	EOS Technologies, Inc. 3160 E. TRANSCON WAY, Suite 180 TUCSON, ARIZONA 85706 USA LICK APF Cabinet Block Diagram
J. Mark Croft	6/2/05	
CHECKED	DATE	
Cal L. Haines	6/2/05	
APPROVED	DATE	
Kevin R. Harris	6/2/05	DOCUMENT NUMBER
CONFIGURED	DATE	SCH-5376-4
Edith Hatch	6/3/05	SIZE
		A3
		EastConfig SCH-5376-4 SHEET 1 OF 64

FILE C:\Ggay\Lick Schematics\SCH-5376-4 APF Cabinet Cable Schematics TEMP\APF_CAB_BLK_DIAG.SCHDOC
 PRINTED 12/8/2009 4:07:19 PM
 TEMPLATE: Eost_tabloid_SUBS

SCH-5376-4 LICK APF Cabinet Block Diagram

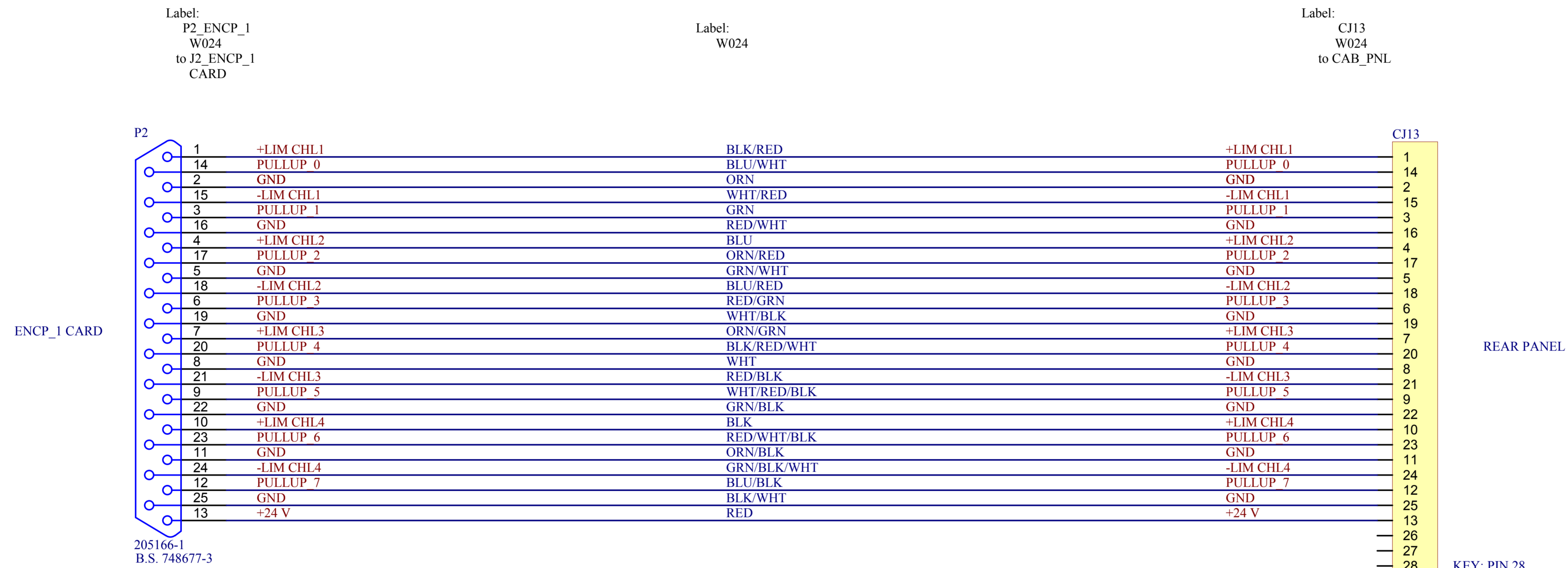

WIRE TYPE: ALPHA 6348
LENGTH: 59"

AZIMUTH LIMIT INPUTS (Includes Failsafes)
ACC24 LIMIT INPUTS [1..4]

© 2005 EOS Technologies, Inc.
Tucson, AZ USA

THIS DOCUMENT & ENCLOSED INFORMATION
REMAINS THE PROPERTY OF EOS
TECHNOLOGIES INC. INTELLECTUAL
PROPERTY AND INFORMATION HEREIN MAY
NOT BE COPIED NOR DISCLOSED WITHOUT
WRITTEN CONSENT OF EOS TECHNOLOGIES,
INC. MANAGEMENT.

FILE C:\GGay\Lick Schematics\SCH-5376-4 APF Cabinet Cable Schematics TEMP\az limits_W024.SCHDOC
PRINTED 12/8/2009 4:07:20 PM
TEMPLATE: Eost_tabloid_SUBS

EOS Technologies, Inc.

3160 E. TRANSCON WAY, Suite 180
TUCSON, ARIZONA 85706 USA

TITLE

APF Azimuth Limit Inputs

DOCUMENT NUMBER

SCH-5376-4

SIZE

A3

EastConfig

SCH-5376-4

SHEET 43

OF

64

Controlled Document
Confirm revision before using

LENGTH: 30 in.

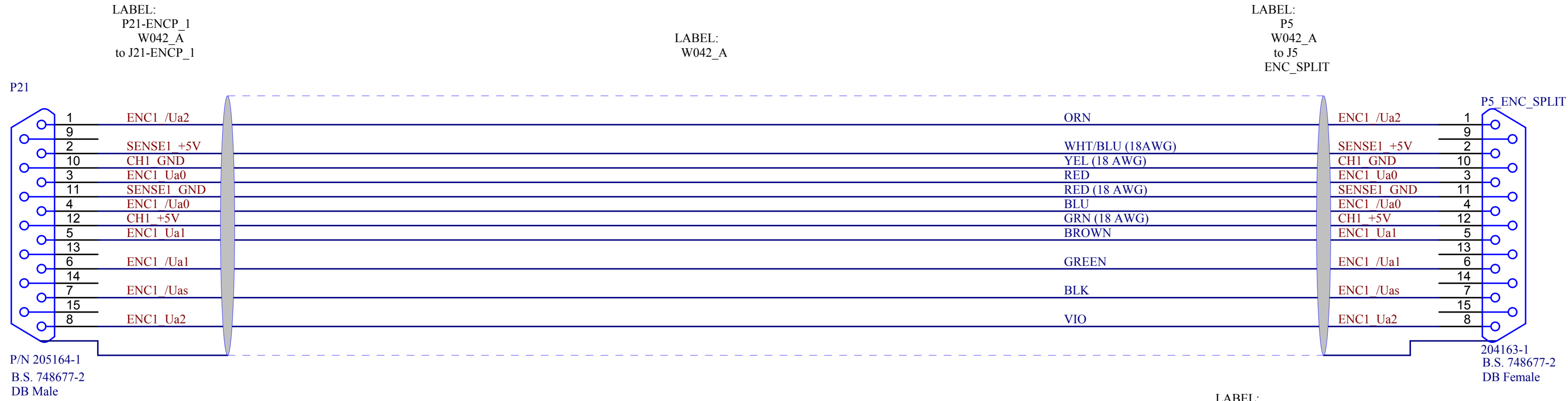

LENGTH: 60 in.

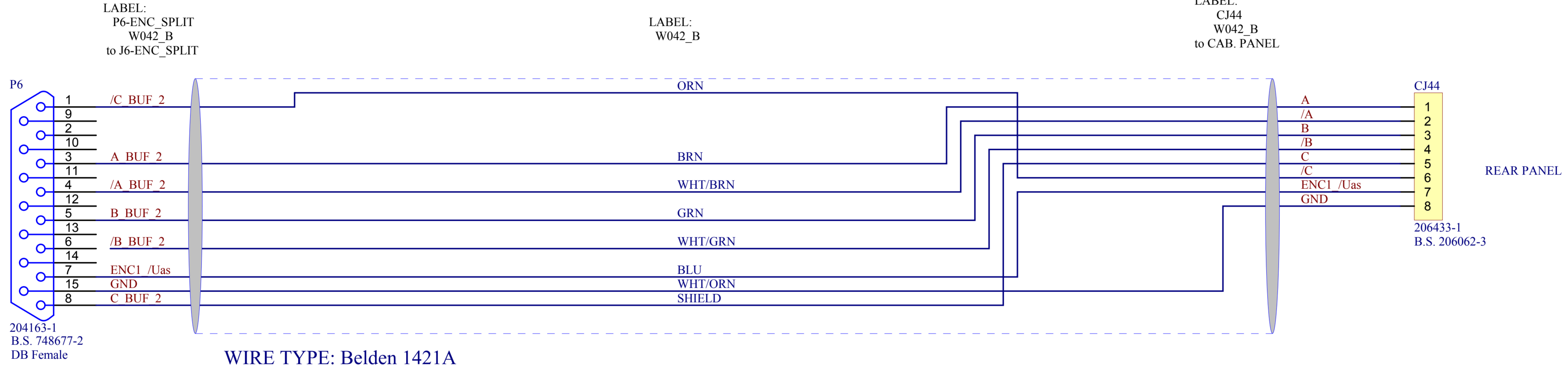

LENGTH: 60 in.

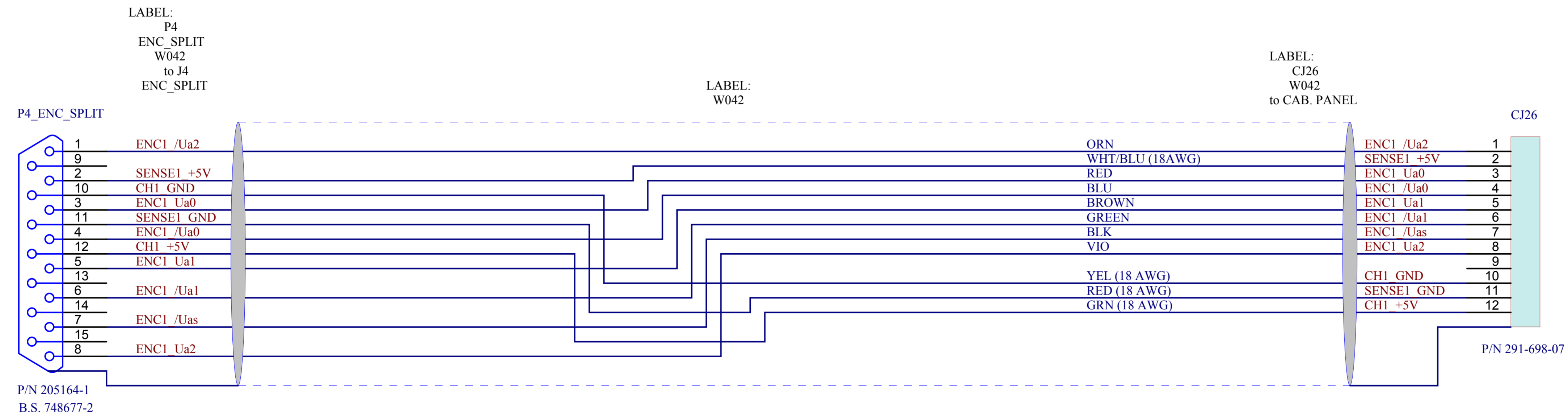

THE SHIELD OF THIS CABLE WAS CONNECTED TO THE METAL CASE OF THE CONNECTOR DURING CABLE ASSEMBLY FABRICATION

© 2005 EOS Technologies, Inc.
Tucson, AZ USA

THIS DOCUMENT & ENCLOSED INFORMATION REMAINS THE PROPERTY OF EOS TECHNOLOGIES INC. INTELLECTUAL PROPERTY AND INFORMATION HEREIN MAY NOT BE COPIED NOR DISCLOSED WITHOUT WRITTEN CONSENT OF EOS TECHNOLOGIES, INC. MANAGEMENT.

FILE C:\GGay\Lick Schematics\SCH-5376-4 APF Cabinet Cable Schematics TEMP\zaenc\W042.SCHDOC
 PRINTED 12/8/2009 4:07:20 PM
 TEMPLATE: Eost_tabloid_SUBS

EOS Technologies, Inc.

3160 E. TRANSCON WAY, Suite 180
 TUCSON, ARIZONA 85706 USA

TITLE
APF Azimuth Encoder A

DOCUMENT NUMBER SIZE

SCH-5376-4

A3

EastConfig SCH-5376-4 SHEET 45 OF 64

APF Azimuth Encoder A

SCH-5376-4

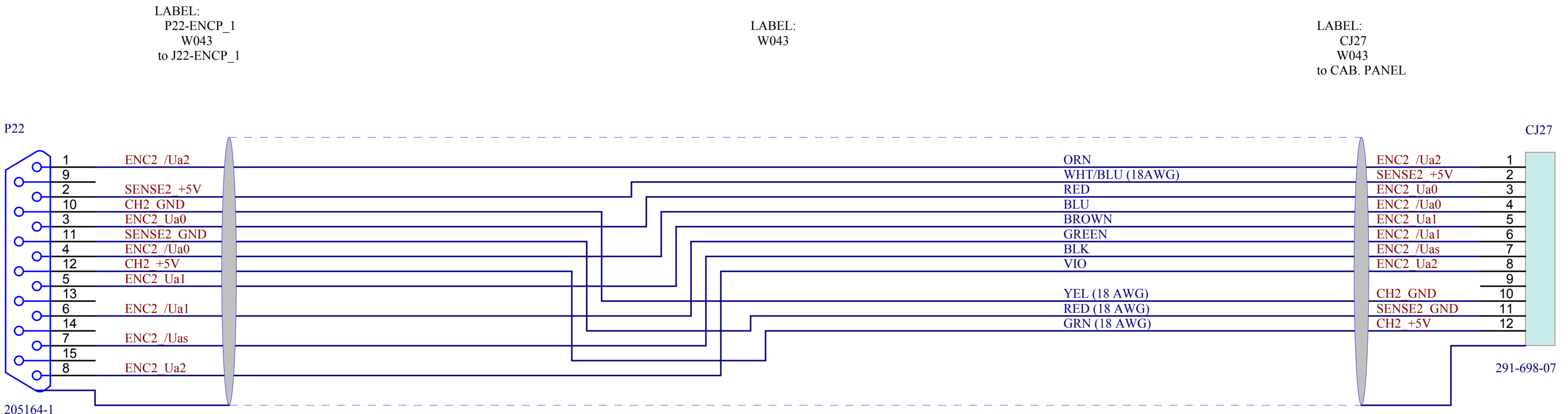

205164-1
B.S. 748677-2

LENGTHS: 60 in.
WIRE TYPE: PETSCHKE OR HEIDENHAIN 244-957-01

291-698-07
THE SHIELD OF THIS CABLE WAS CONNECTED TO THE METAL CASE OF THE CONNECTOR DURING CABLE ASSEMBLY FABRICATION

© 2005 EOS Technologies, Inc.
Tucson, AZ USA

THIS DOCUMENT & ENCLOSED INFORMATION REMAINS THE PROPERTY OF EOS TECHNOLOGIES INC. INTELLECTUAL PROPERTY AND INFORMATION HEREIN MAY NOT BE COPIED NOR DISCLOSED WITHOUT WRITTEN CONSENT OF EOS TECHNOLOGIES, INC. MANAGEMENT.

FILE C:\GGay\Lick Schematics\SCH-5376-4 APF Cabinet Cable Schematics TEMP\azbenc\W043.SCHDOC
PRINTED 12/8/2009 4:07:21 PM
TEMPLATE: Eost_tabloid_SUBS

EOS Technologies, Inc.
3160 E. TRANSCON WAY, Suite 180
TUCSON, ARIZONA 85706 USA

TITLE
APF Azimuth Encoder B

DOCUMENT NUMBER
SCH-5376-4

EastConfig SCH-5376-4 SHEET 46 OF 64

SIZE
A3

APF Azimuth Encoder B
SCH-5376-4

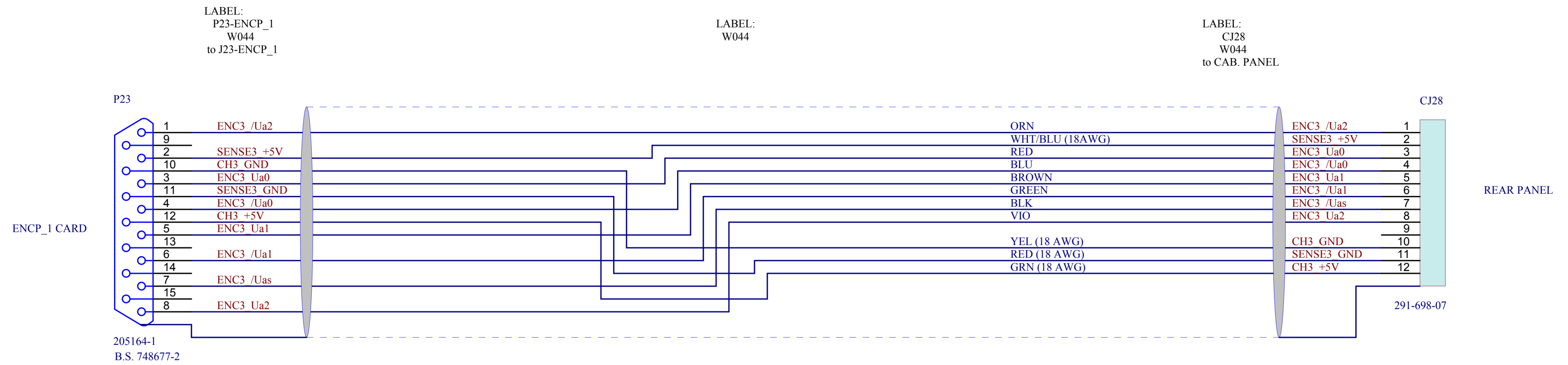

LENGTHS: 60 in.
WIRE TYPE: PETSCHKE OR HEIDENHAIN 244-957-01

THE SHIELD OF THIS CABLE WAS CONNECTED TO THE METAL CASE OF THE CONNECTOR DURING CABLE ASSEMBLY FABRICATION

© 2005 EOS Technologies, Inc.
Tucson, AZ USA

THIS DOCUMENT & ENCLOSED INFORMATION REMAINS THE PROPERTY OF EOS TECHNOLOGIES INC. INTELLECTUAL PROPERTY AND INFORMATION HEREIN MAY NOT BE COPIED NOR DISCLOSED WITHOUT WRITTEN CONSENT OF EOS TECHNOLOGIES, INC. MANAGEMENT.

FILE C:\GGay\Lick Schematics\SCH-5376-4 APF Cabinet Cable Schematics TEMP\azcenc\W044.SCHDOC
PRINTED 12/8/2009 4:07:22 PM
TEMPLATE: Eost_tabloid_SUBS

EOS Technologies, Inc.

3160 E. TRANSCON WAY, Suite 180
TUCSON, ARIZONA 85706 USA

TITLE

APF Azimuth Encoder C

DOCUMENT NUMBER

SCH-5376-4

SIZE

A3

EastConfig

SCH-5376-4

SHEET 47 OF

64

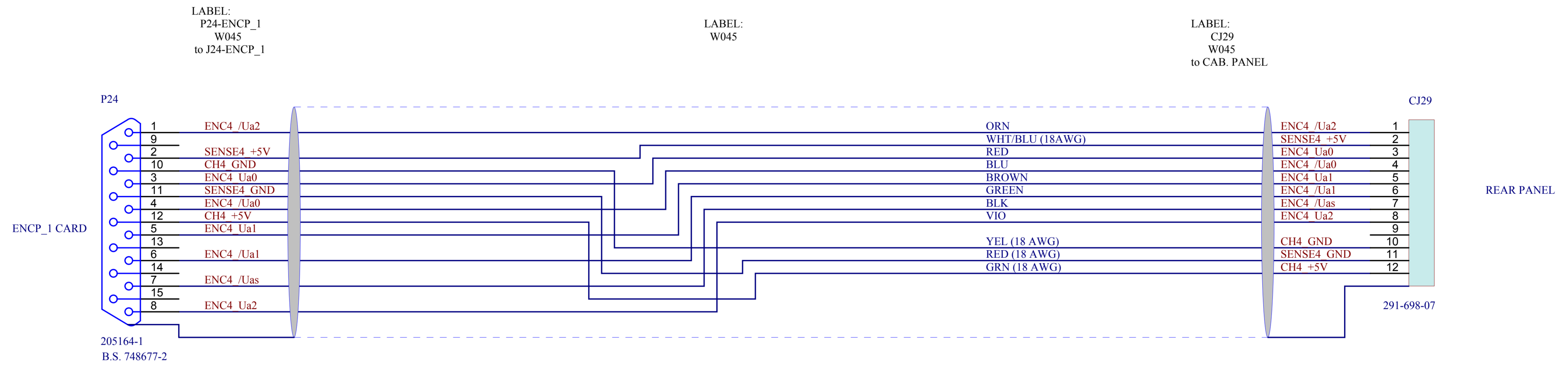

LENGTHS: 60 in.
WIRE TYPE: PETSCHKE OR HEIDENHAIN 244-957-01

THE SHIELD OF THIS CABLE WAS CONNECTED TO THE METAL CASE OF THE CONNECTOR DURING CABLE ASSEMBLY FABRICATION

© 2005 EOS Technologies, Inc.
Tucson, AZ USA

THIS DOCUMENT & ENCLOSED INFORMATION REMAINS THE PROPERTY OF EOS TECHNOLOGIES INC. INTELLECTUAL PROPERTY AND INFORMATION HEREIN MAY NOT BE COPIED NOR DISCLOSED WITHOUT WRITTEN CONSENT OF EOS TECHNOLOGIES, INC. MANAGEMENT.

FILE C:\GGay\Lick Schematics\SCH-5376-4 APF Cabinet Cable Schematics TEMP\azdenc\W045.SCHDOC
PRINTED 12/8/2009 4:07:23 PM
TEMPLATE: Eost_tabloid_SUBS

EOS Technologies, Inc.

3160 E. TRANSCON WAY, Suite 180
TUCSON, ARIZONA 85706 USA

TITLE

APF Azimuth Encoder D

DOCUMENT NUMBER

SCH-5376-4

SIZE

A3

EastConfig SCH-5376-4

SHEET 48 OF 64

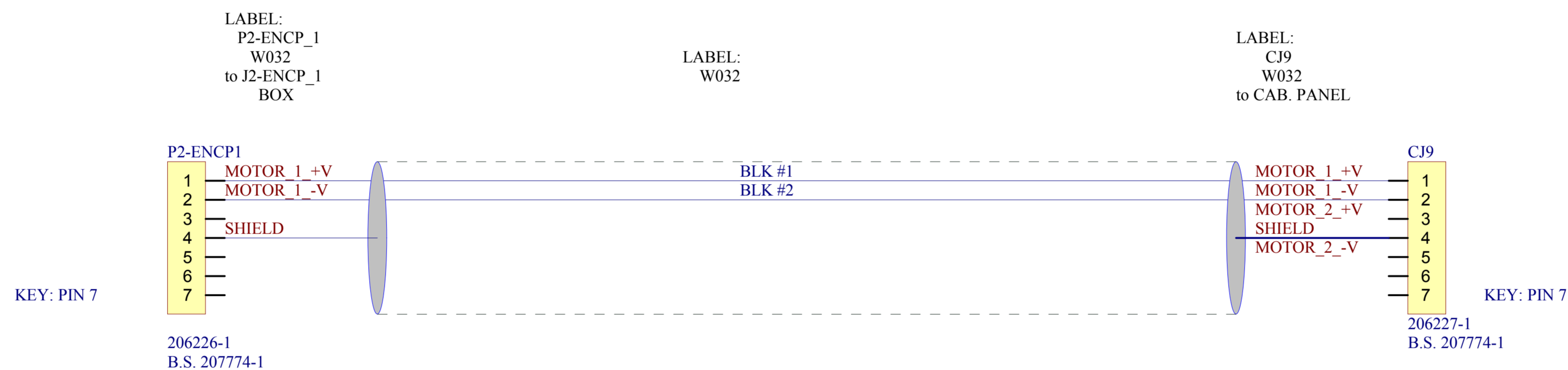

AZIMUTH MOTOR DRIVE

LENGTHS: 65.5"
WIRE TYPE: Alpha 87703CY

© 2005 EOS Technologies, Inc.
Tucson, AZ USA

THIS DOCUMENT & ENCLOSED INFORMATION
REMAINS THE PROPERTY OF EOS
TECHNOLOGIES INC. INTELLECTUAL
PROPERTY AND INFORMATION HEREIN MAY
NOT BE COPIED NOR DISCLOSED WITHOUT
WRITTEN CONSENT OF EOS TECHNOLOGIES,
INC. MANAGEMENT.

FILE C:\GGay\Lick Schematics\SCH-5376-4 APF Cabinet Cable Schematics TEMPlazdrvW032.SCHDOC
PRINTED 12/8/2009 4:07:24 PM
TEMPLATE: Eost_tabloid_SUBS

EOS Technologies, Inc.
3160 E. TRANSCON WAY, Suite 180
TUCSON, ARIZONA 85706 USA

TITLE
APF Azimuth Motor Drive

DOCUMENT NUMBER
SCH-5376-4

SIZE
A3

EostConfig SCH-5376-4 SHEET 44 OF 64

CABINET FAN POWER

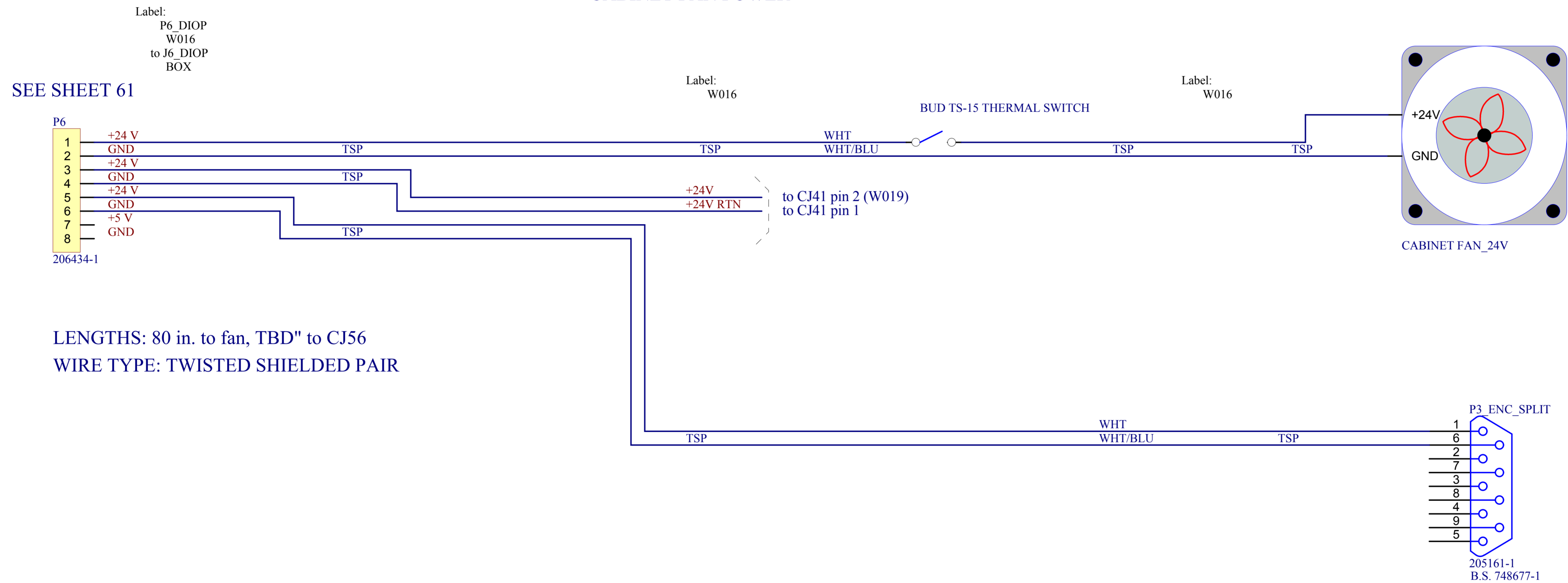

© 2005 EOS Technologies, Inc.
Tucson, AZ USA

THIS DOCUMENT & ENCLOSED INFORMATION
REMAINS THE PROPERTY OF EOS
TECHNOLOGIES INC. INTELLECTUAL
PROPERTY AND INFORMATION HEREIN MAY
NOT BE COPIED NOR DISCLOSED WITHOUT
WRITTEN CONSENT OF EOS TECHNOLOGIES,
INC. MANAGEMENT.

FILE C:\GGay\Lick Schematics\SCH-5376-4 APF Cabinet Cable Schematics TEMP\cabfanW016.SCHDOC
PRINTED 12/8/2009 4:07:24 PM
TEMPLATE: Eost_tabloid_SUBS

EOS Technologies, Inc.
3160 E. TRANSCON WAY, Suite 180
TUCSON, ARIZONA 85706 USA

TITLE
APF TCC Cooling Fan

DOCUMENT NUMBER
SCH-5376-4

EostConfig SCH-5376-4 SHEET 59 OF 64

SIZE
A3

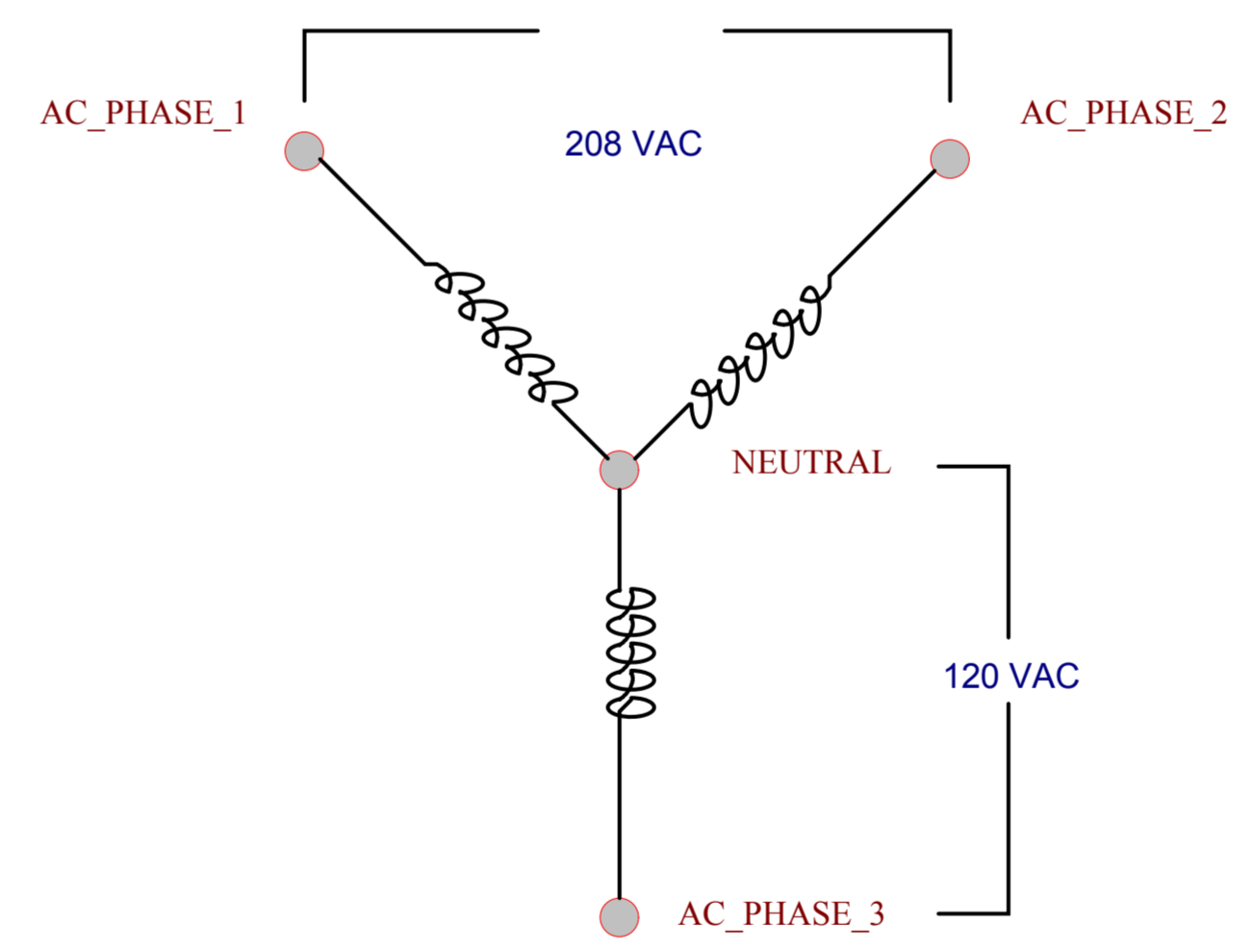
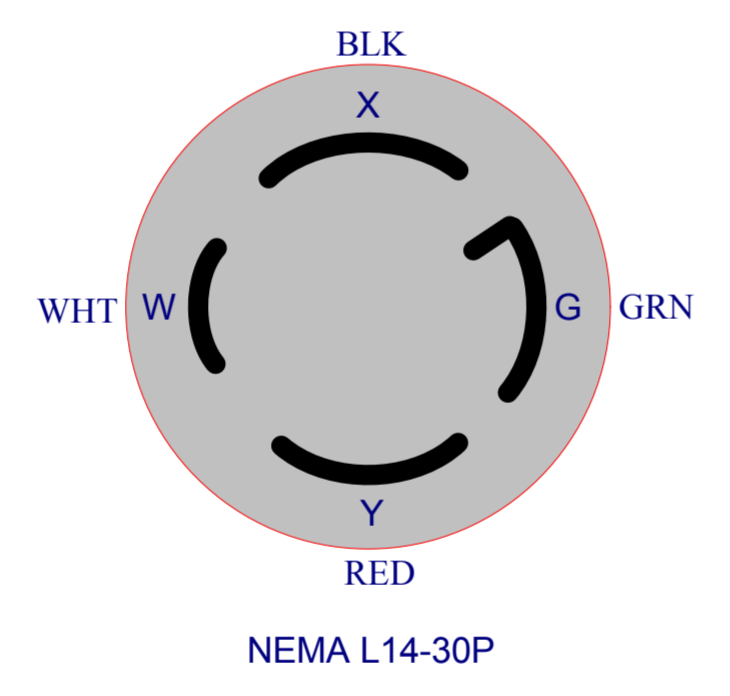
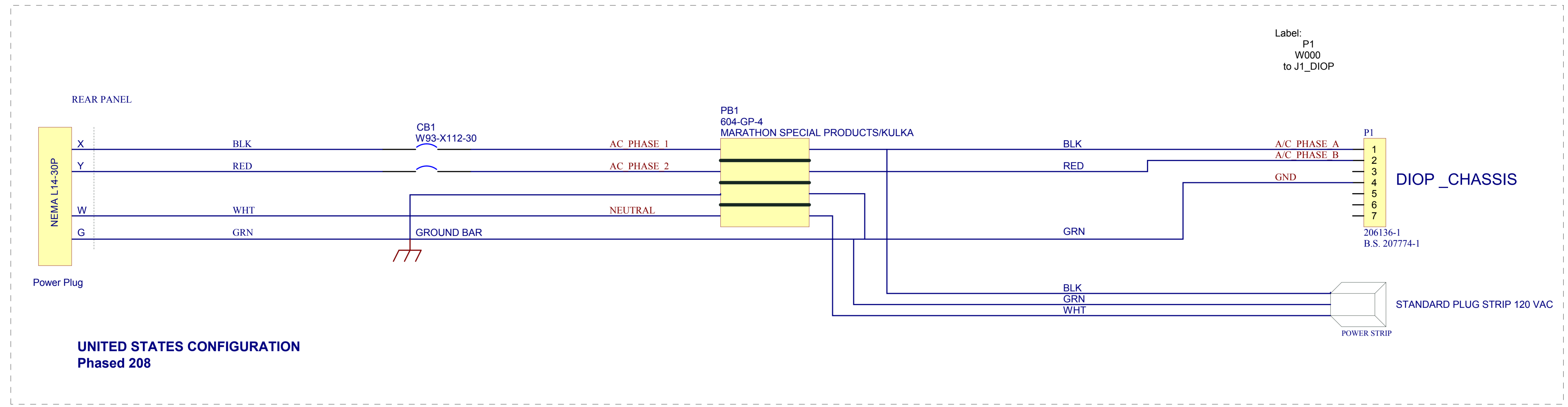

LENGTHS:

- 1) BACK PANEL TO CB1: 228.6CM (90")
- 2) CB1 TO AC PWR DIST: 15.25CM (6")
- 3) AC PWR DIST TO AC LAMP: 20.3CM (8")
- 4) AC PWR DIST TO P6: 267.5CM (85")
- 5) CB1 TO COMPUTER: 119.4CM (47")

WIRE TYPE:

LENGTHS 1 & 2 & 4 ARE Alpha 87605
 LENGTH NO. 3 IS 2EA 20GA.
 LENGTH N0.5 IS THE POWER CORD PROVIDED BY THE MANF. CUT TO LENGTH.

© 2005 EOS Technologies, Inc.
Tucson, AZ USA

THIS DOCUMENT & ENCLOSED INFORMATION
REMAINS THE PROPERTY OF EOS
TECHNOLOGIES INC. INTELLECTUAL
PROPERTY AND INFORMATION HEREIN MAY
NOT BE COPIED NOR DISCLOSED WITHOUT
WRITTEN CONSENT OF EOS TECHNOLOGIES,
INC. MANAGEMENT.

FILE C:\GGay\Lick Schematics\SCH-5376-4 APF Cabinet Cable Schematics TEMP\cabpowerW000.SCHDOC
 PRINTED 12/8/2009 4:07:25 PM
 TEMPLATE: Eost_tabloid_SUBS

EOS Technologies, Inc.

3160 E. TRANSCON WAY, Suite 180
TUCSON, ARIZONA 85706 USA

TITLE
LICK APF Cabinet Power Connection

DOCUMENT NUMBER
SCH-5376-4

SIZE
A3

EastConfig SCH-5376-4 SHEET 3 OF 70

DIO96 INTERFACE

Controlled Document
Confirm revision before using

DIOP

P16
71602-050

P17
71602-050

LABEL:
P16-DIOP
W012
to J16-DIOP

LABEL:
P17-DIOP
W012
to J17-DIOP

LABEL:
W012

LABEL:
W012

LABEL:
PDIO 96 CARD
W012
to JDIO 96 CARD

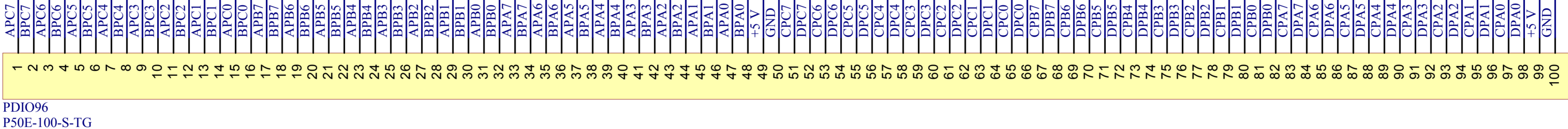

WIRE TYPE:843-191-2801-050
LENGTHS: 18"

DIO_96

© 2005 EOS Technologies, Inc.
Tucson, AZ USA

THIS DOCUMENT & ENCLOSED INFORMATION
REMAINS THE PROPERTY OF EOS
TECHNOLOGIES INC. INTELLECTUAL
PROPERTY AND INFORMATION HEREIN MAY
NOT BE COPIED NOR DISCLOSED WITHOUT
WRITTEN CONSENT OF EOS TECHNOLOGIES,
INC. MANAGEMENT.

FILE C:\GGay\Lick Schematics\SCH-5376-4 APF Cabinet Cable Schematics TEMP\dio96W012.SCHDOC
PRINTED 12/8/2009 4:07:26 PM
TEMPLATE: Eost_tabloid_SUBS

EOS Technologies, Inc.
3160 E. TRANSCON WAY, Suite 180
TUCSON, ARIZONA 85706 USA

TITLE
LICK APF DIOP to DIO96 Interface

DOCUMENT NUMBER	SIZE
SCH-5376-4	A3
EastConfig SCH-5376-4	SHEET 24 OF 64

SCH-5376-4 LICK APF DIOP to DIO96 Interface

I/O BUS DIOP to ENCP_0

Label:
P1_DIOP
W013
to J1_DIOP
CARD

Label:
W013

Label:
P15_ENCP_0
W013
to J15_ENCP_0

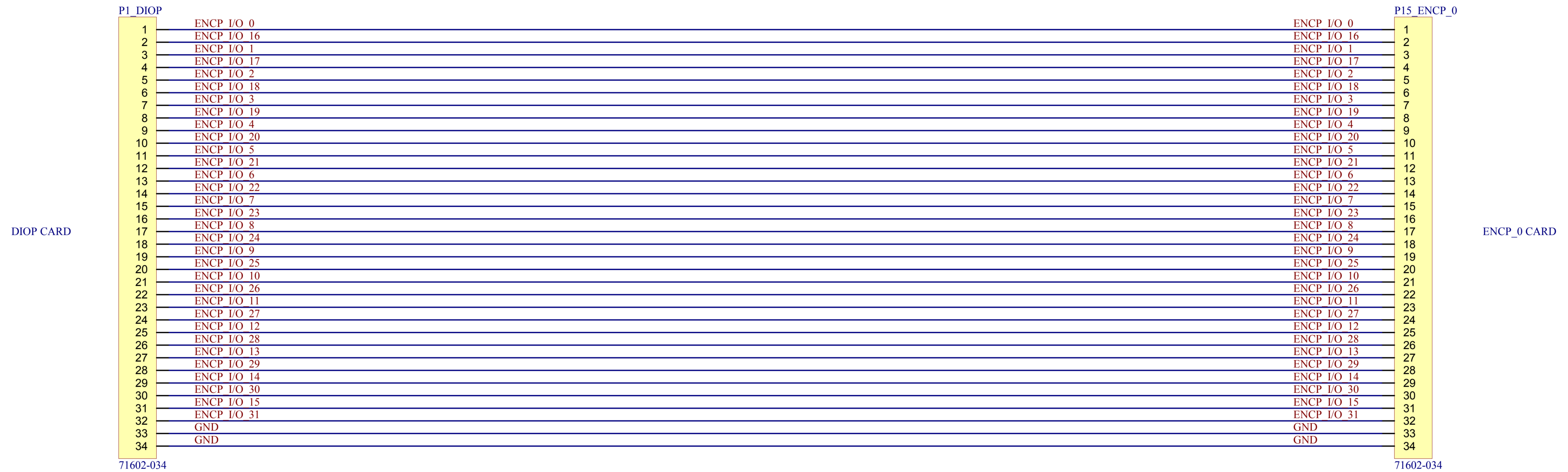

WIRE TYPE: 34 Conductor Ribbon Cable
LENGTH: 37"

© 2005 EOS Technologies, Inc.
Tucson, AZ USA

THIS DOCUMENT & ENCLOSED INFORMATION
REMAINS THE PROPERTY OF EOS
TECHNOLOGIES INC. INTELLECTUAL
PROPERTY AND INFORMATION HEREIN MAY
NOT BE COPIED NOR DISCLOSED WITHOUT
WRITTEN CONSENT OF EOS TECHNOLOGIES,
INC. MANAGEMENT.

FILE C:\GGay\Lick Schematics\SCH-5376-4 APF Cabinet Cable Schematics TEMP\diopencpW013.SCHDOC
PRINTED 12/8/2009 4:07:27 PM
TEMPLATE: Eost_tabloid_SUBS

EOS Technologies, Inc.

3160 E. TRANSCON WAY, Suite 180
TUCSON, ARIZONA 85706 USA

TITLE

LICK APF ENCP0 to DIOP Interface

DOCUMENT NUMBER

SCH-5376-4

SIZE

A3

EastConfig

SCH-5376-4

SHEET 17

OF

64

Label:
P3_ENCP_1
W025
to J3_ENCP_1

Label:
W025

Label:
CJ14
W025
to CAB_PNL

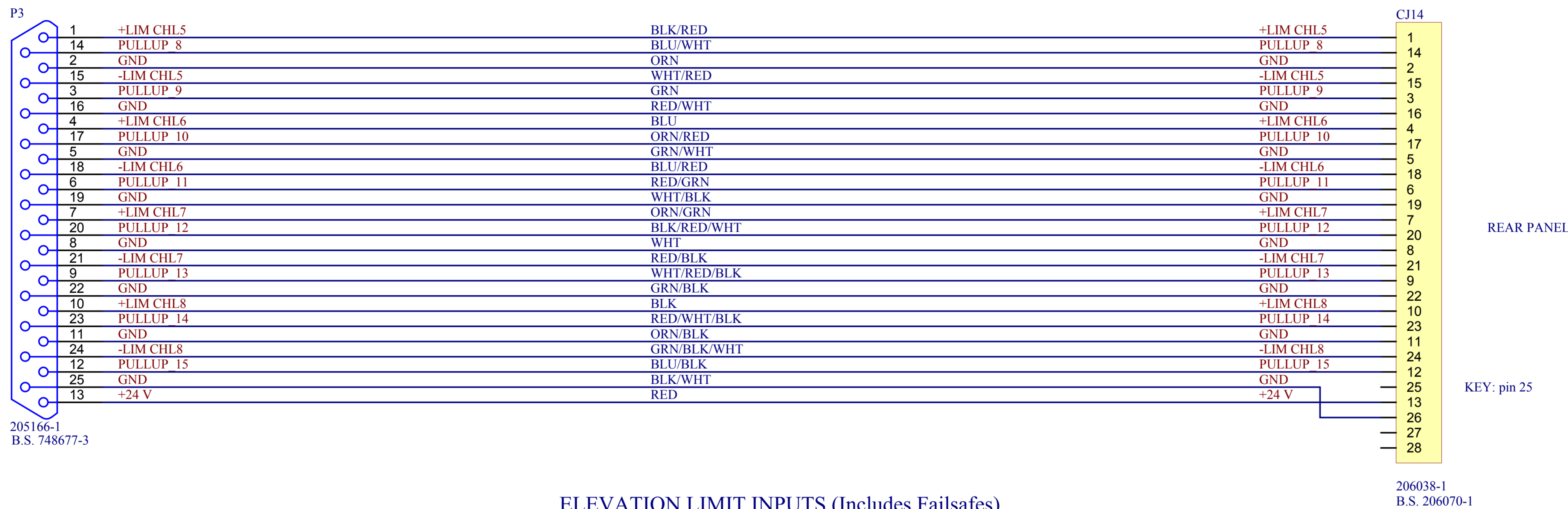

WIRE TYPE: ALPHA 6348
LENGTH: 59.5"

ELEVATION LIMIT INPUTS (Includes Failsafes)
ACC24 LIMIT INPUTS [5..8]

© 2005 EOS Technologies, Inc.
Tucson, AZ USA

THIS DOCUMENT & ENCLOSED INFORMATION
REMAINS THE PROPERTY OF EOS
TECHNOLOGIES INC. INTELLECTUAL
PROPERTY AND INFORMATION HEREIN MAY
NOT BE COPIED NOR DISCLOSED WITHOUT
WRITTEN CONSENT OF EOS TECHNOLOGIES,
INC. MANAGEMENT.

FILE C:\GGay\Lick Schematics\SCH-5376-4 APF Cabinet Cable Schematics TEMPlimits_W025.SCHDOC
PRINTED 12/8/2009 4:07:28 PM
TEMPLATE: Eost_tabloid_SUBS

EOS Technologies, Inc.

3160 E. TRANSCON WAY, Suite 180
TUCSON, ARIZONA 85706 USA

TITLE

APF Elevation Limit Inputs

DOCUMENT NUMBER

SCH-5376-4

SIZE

A3

EastConfig

SCH-5376-4

SHEET 50

OF

64

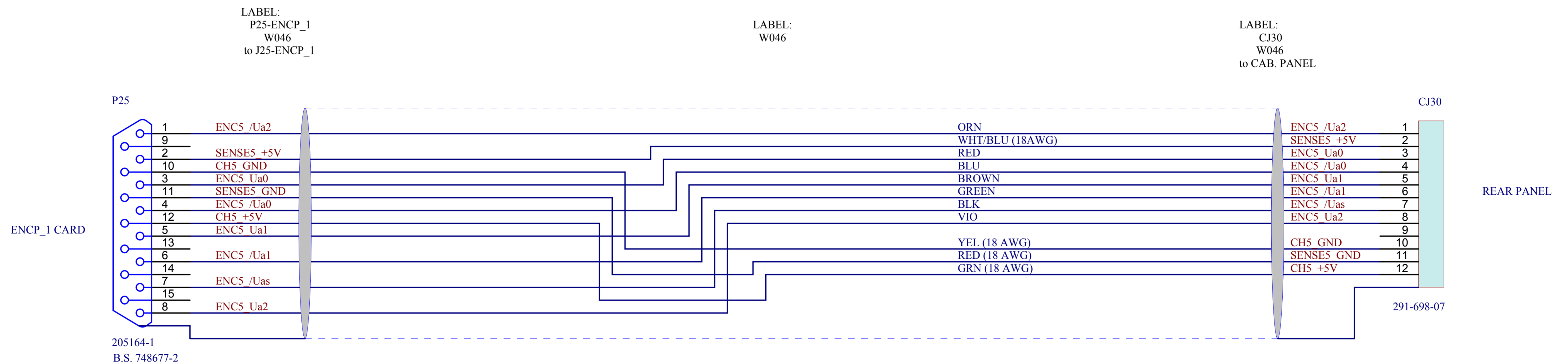

THE SHIELD OF THIS CABLE WAS CONNECTED TO THE METAL CASE OF THE CONNECTOR DURING CABLE ASSEMBLY FABRICATION

LENGTHS: 60 in.
WIRE TYPE: PETSCHKE OR HEIDENHAIN 244-957-01

© 2005 EOS Technologies, Inc.
Tucson, AZ USA

THIS DOCUMENT & ENCLOSED INFORMATION REMAINS THE PROPERTY OF EOS TECHNOLOGIES INC. INTELLECTUAL PROPERTY AND INFORMATION HEREIN MAY NOT BE COPIED NOR DISCLOSED WITHOUT WRITTEN CONSENT OF EOS TECHNOLOGIES, INC. MANAGEMENT.

FILE C:\GGay\Lick Schematics\SCH-5376-4 APF Cabinet Cable Schematics TEMP\elaencW046.SCHDOC
PRINTED 12/8/2009 4:07:29 PM
TEMPLATE: Eost_tabloid_SUBS

EOS Technologies, Inc.
3160 E. TRANSCON WAY, Suite 180
TUCSON, ARIZONA 85706 USA

TITLE
APF Elevation Encoder A

DOCUMENT NUMBER	SCH-5376-4	SIZE	A3
-----------------	-------------------	------	-----------

EostConfig	SCH-5376-4	SHEET 51 OF 64
------------	------------	----------------

APF Elevation Encoder A
SCH-5376-4

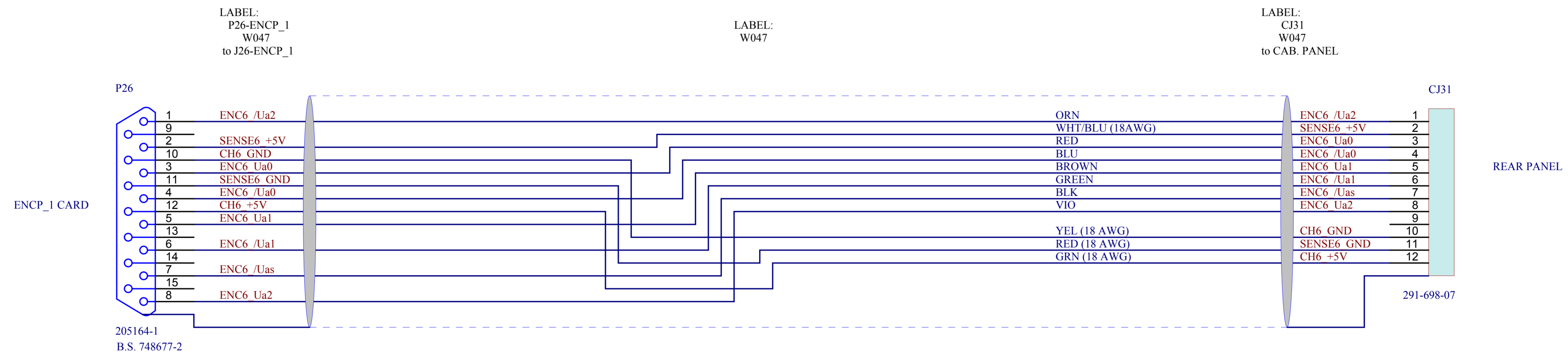

LENGTHS: 60 in.
WIRE TYPE: PETSCHKE OR HEIDENHAIN 244-957-01

THE SHIELD OF THIS CABLE WAS CONNECTED TO THE METAL CASE OF THE CONNECTOR DURING CABLE ASSEMBLY FABRICATION

© 2005 EOS Technologies, Inc.
Tucson, AZ USA

THIS DOCUMENT & ENCLOSED INFORMATION REMAINS THE PROPERTY OF EOS TECHNOLOGIES INC. INTELLECTUAL PROPERTY AND INFORMATION HEREIN MAY NOT BE COPIED NOR DISCLOSED WITHOUT WRITTEN CONSENT OF EOS TECHNOLOGIES, INC. MANAGEMENT.

FILE C:\GGay\Lick Schematics\SCH-5376-4 APF Cabinet Cable Schematics TEMPlabencW047.SCHDOC
PRINTED 12/8/2009 4:07:29 PM
TEMPLATE: Eost_tabloid_SUBS

EOS Technologies, Inc.
3160 E. TRANSCON WAY, Suite 180
TUCSON, ARIZONA 85706 USA

TITLE
APF Elevation Encoder B

DOCUMENT NUMBER	SIZE
SCH-5376-4	A3
EastConfig SCH-5376-4	SHEET 52 OF 64

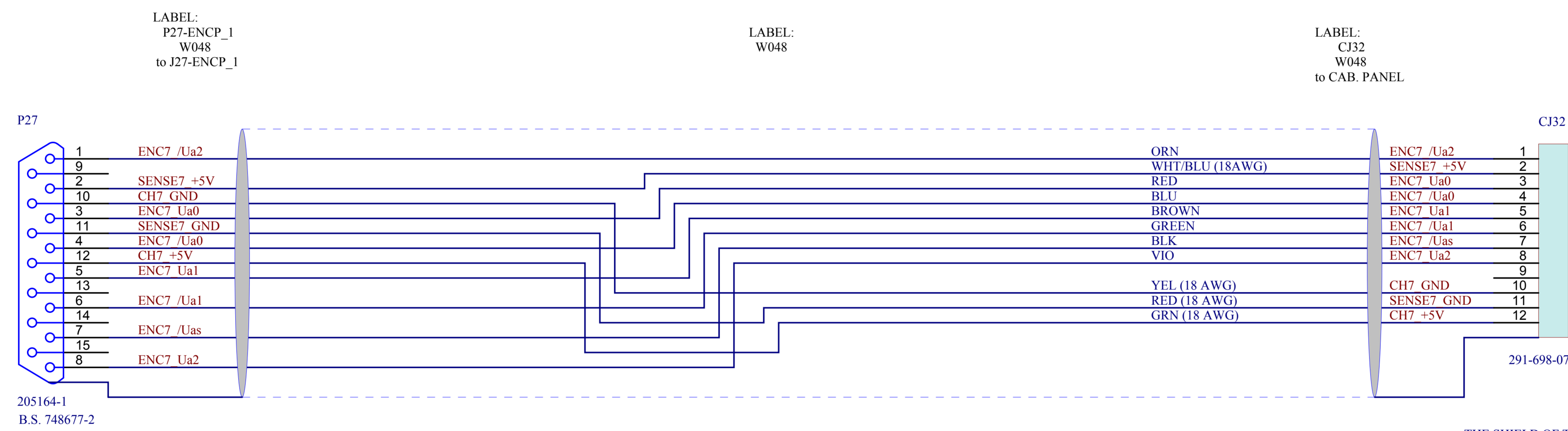

LENGTHS: 60 in.
WIRE TYPE: PETSCHKE OR HEIDENHAIN 244-957-01

THE SHIELD OF THIS CABLE WAS CONNECTED TO THE METAL CASE OF THE CONNECTOR DURING CABLE ASSEMBLY FABRICATION

© 2005 EOS Technologies, Inc.
Tucson, AZ USA

THIS DOCUMENT & ENCLOSED INFORMATION REMAINS THE PROPERTY OF EOS TECHNOLOGIES INC. INTELLECTUAL PROPERTY AND INFORMATION HEREIN MAY NOT BE COPIED NOR DISCLOSED WITHOUT WRITTEN CONSENT OF EOS TECHNOLOGIES, INC. MANAGEMENT.

FILE C:\GGay\Lick Schematics\SCH-5376-4 APF Cabinet Cable Schematics TEMP\elcencW048.SCHDOC
PRINTED 12/8/2009 4:07:30 PM
TEMPLATE: Eost_tabloid_SUBS

EOS Technologies, Inc.
3160 E. TRANSCON WAY, Suite 180
TUCSON, ARIZONA 85706 USA

TITLE
APF Elevation Encoder C

DOCUMENT NUMBER
SCH-5376-4

EastConfig SCH-5376-4 SHEET 53 OF 64

SIZE
A3

APF Elevation Encoder C
SCH-5376-4

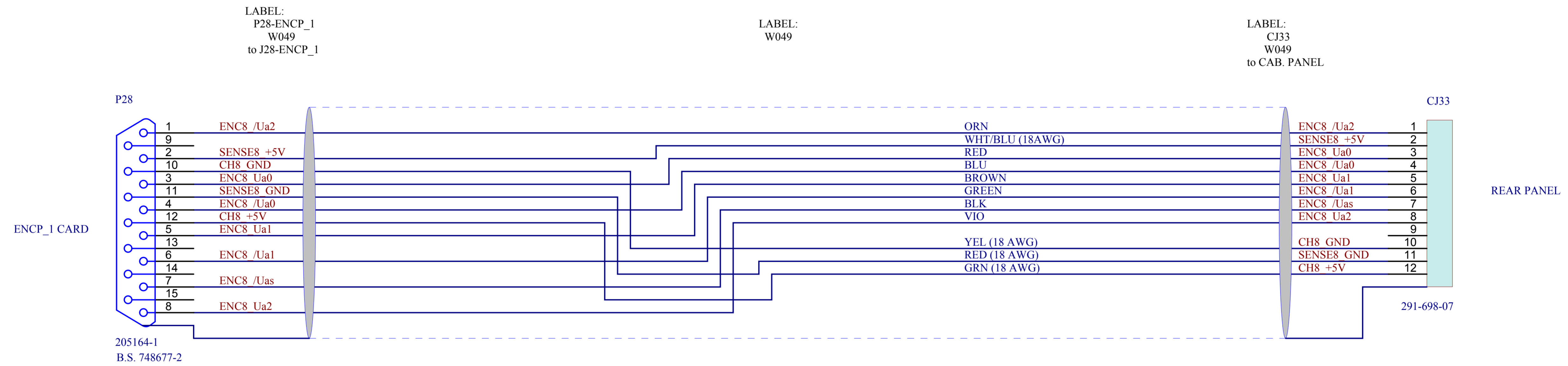

LENGTHS: 60 in.
WIRE TYPE: PETSCHKE OR HEIDENHAIN 244-957-01

THE SHIELD OF THIS CABLE WAS CONNECTED TO THE METAL CASE OF THE CONNECTOR DURING CABLE ASSEMBLY FABRICATION

© 2005 EOS Technologies, Inc.
Tucson, AZ USA

THIS DOCUMENT & ENCLOSED INFORMATION REMAINS THE PROPERTY OF EOS TECHNOLOGIES INC. INTELLECTUAL PROPERTY AND INFORMATION HEREIN MAY NOT BE COPIED NOR DISCLOSED WITHOUT WRITTEN CONSENT OF EOS TECHNOLOGIES, INC. MANAGEMENT.

FILE C:\GGay\Lick Schematics\SCH-5376-4 APF Cabinet Cable Schematics TEMP\elencW049.SCHDOC
PRINTED 12/8/2009 4:07:31 PM
TEMPLATE: Eost_tabloid_SUBS

EOS Technologies, Inc.
3160 E. TRANSCON WAY, Suite 180
TUCSON, ARIZONA 85706 USA

TITLE
APF Elevation Encoder D

DOCUMENT NUMBER	SCH-5376-4	SIZE	A3
EostConfig	SCH-5376-4	SHEET 54	OF 64

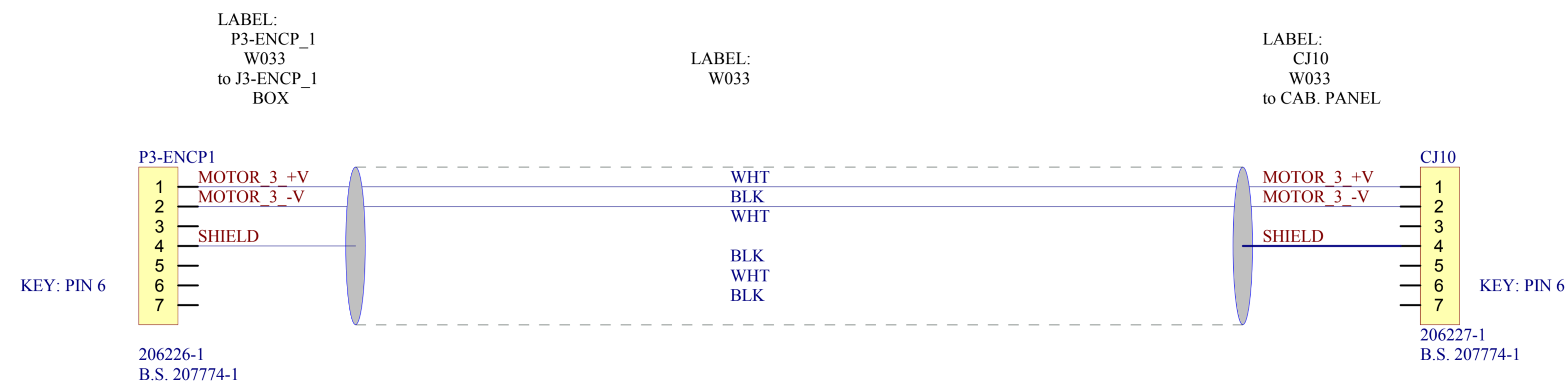

ELEVATION MOTOR DRIVE

LENGTHS: 64"
WIRE TYPE: Alpha 87703CY

© 2005 EOS Technologies, Inc.
Tucson, AZ USA

THIS DOCUMENT & ENCLOSED INFORMATION
REMAINS THE PROPERTY OF EOS
TECHNOLOGIES INC. INTELLECTUAL
PROPERTY AND INFORMATION HEREIN MAY
NOT BE COPIED NOR DISCLOSED WITHOUT
WRITTEN CONSENT OF EOS TECHNOLOGIES,
INC. MANAGEMENT.

FILE C:\GGay\Lick Schematics\SCH-5376-4 APF Cabinet Cable Schematics TEMP\eldrvW033.SCHDOC
PRINTED 12/8/2009 4:07:32 PM
TEMPLATE: Eost_tabloid_SUBS

EOS Technologies, Inc.

3160 E. TRANSCON WAY, Suite 180
TUCSON, ARIZONA 85706 USA

TITLE

APF Elevation Motor Drive

DOCUMENT NUMBER

SCH-5376-4

SIZE

A3

EastConfig SCH-5376-4

SHEET 49 OF 64

ENCP_0 CARD POWER

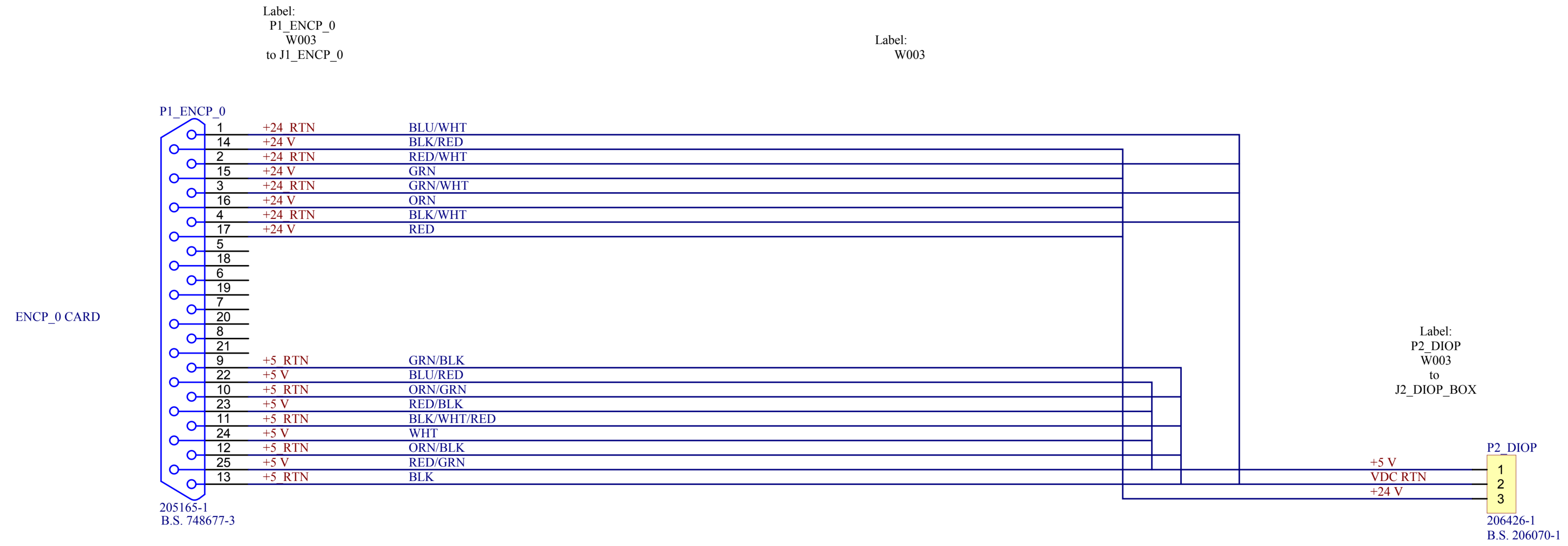

WIRE TYPE: ALPHA 6348
LENGTH: 44"

© 2005 EOS Technologies, Inc.
Tucson, AZ USA

THIS DOCUMENT & ENCLOSED INFORMATION
REMAINS THE PROPERTY OF EOS
TECHNOLOGIES INC. INTELLECTUAL
PROPERTY AND INFORMATION HEREIN MAY
NOT BE COPIED NOR DISCLOSED WITHOUT
WRITTEN CONSENT OF EOS TECHNOLOGIES,
INC. MANAGEMENT.

FILE C:\GGay\Lick Schematics\SCH-5376-4 APF Cabinet Cable Schematics TEMPlencp0cardpowerW003.SCHDOC
PRINTED 12/8/2009 4:07:32 PM
TEMPLATE: Eost_tabloid_SUBS

EOS Technologies, Inc.

3160 E. TRANSCON WAY, Suite 180
TUCSON, ARIZONA 85706 USA

TITLE

LICK APF ENCP0 Card Power

DOCUMENT NUMBER

SCH-5376-4

SIZE

A3

EastConfig SCH-5376-4

SHEET 15 OF 64

ENCP_0 AMPLIFIER POWER

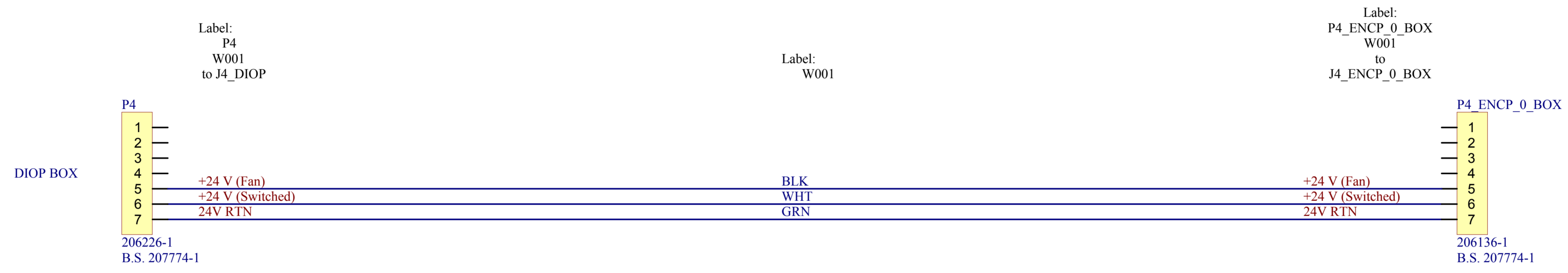

WIRE TYPE: BELDEN 3 COND. 12 GA.
LENGTH: 46"

© 2005 EOS Technologies, Inc.
Tucson, AZ USA

THIS DOCUMENT & ENCLOSED INFORMATION
REMAINS THE PROPERTY OF EOS
TECHNOLOGIES INC. INTELLECTUAL
PROPERTY AND INFORMATION HEREIN MAY
NOT BE COPIED NOR DISCLOSED WITHOUT
WRITTEN CONSENT OF EOS TECHNOLOGIES,
INC. MANAGEMENT.

FILE C:\GGay\Lick Schematics\SCH-5376-4 APF Cabinet Cable Schematics TEMPlencp0powerW001.SCHDOC
PRINTED 12/8/2009 4:07:33 PM
TEMPLATE: Eost_tabloid_SUBS

EOS Technologies, Inc.

3160 E. TRANSCON WAY, Suite 180
TUCSON, ARIZONA 85706 USA

TITLE

LICK APF ENCP0 Power

DOCUMENT NUMBER

SCH-5376-4

SIZE

A3

EostConfig SCH-5376-4

SHEET 14 OF 64

ENCP_1 CARD POWER

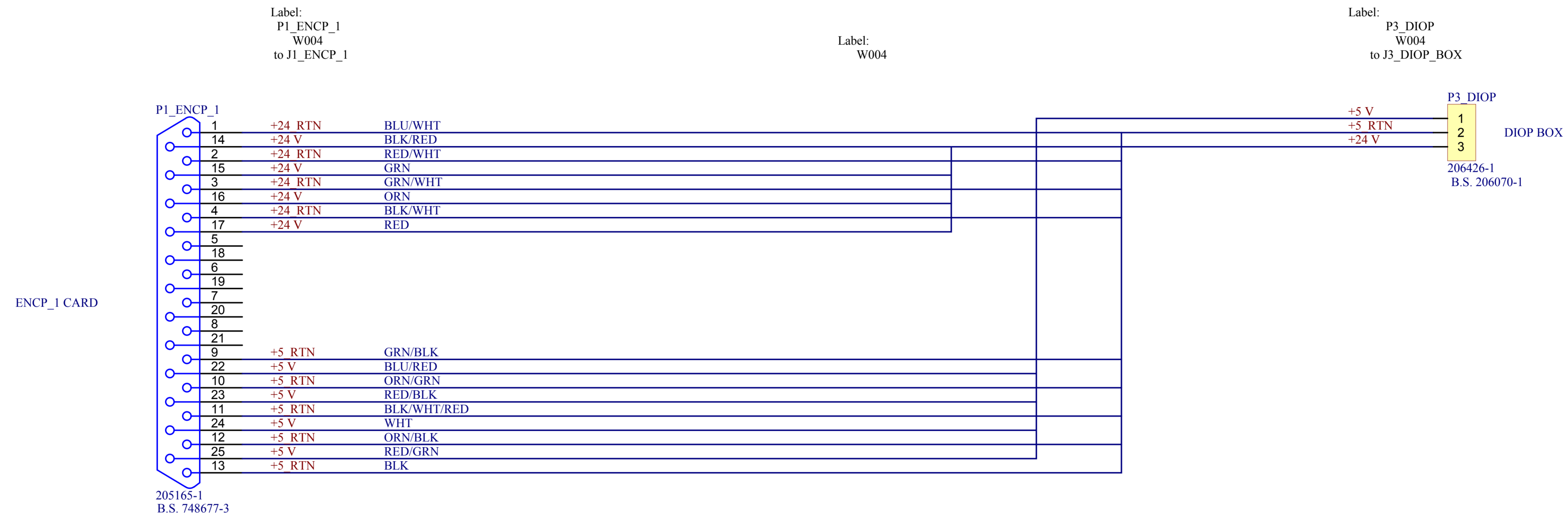

WIRE TYPE: ALPHA 6348
LENGTH: 41"

© 2005 EOS Technologies, Inc.
Tucson, AZ USA

THIS DOCUMENT & ENCLOSED INFORMATION
REMAINS THE PROPERTY OF EOS
TECHNOLOGIES INC. INTELLECTUAL
PROPERTY AND INFORMATION HEREIN MAY
NOT BE COPIED NOR DISCLOSED WITHOUT
WRITTEN CONSENT OF EOS TECHNOLOGIES,
INC. MANAGEMENT.

FILE C:\GGay\Lick Schematics\SCH-5376-4 APF Cabinet Cable Schematics TEMPlencp1cardpowerW004.SCHDOC
PRINTED 12/8/2009 4:07:34 PM
TEMPLATE: Eost_tabloid_SUBS

EOS Technologies, Inc.

3160 E. TRANSCON WAY, Suite 180
TUCSON, ARIZONA 85706 USA

TITLE

LICK APF ENCP1 Card Power

DOCUMENT NUMBER

SCH-5376-4

SIZE

A3

EastConfig SCH-5376-4

SHEET 13 OF 64

ENC1 AMPLIFIER POWER

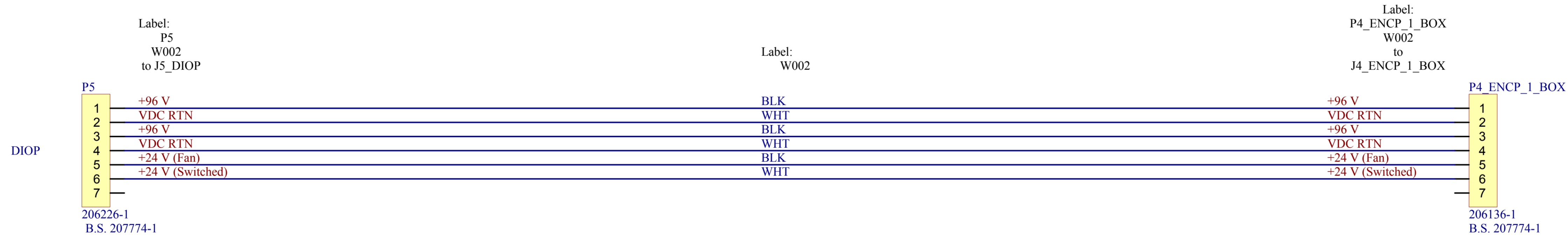

LENGTH: 47"
WIRE TYPE: PVAZBD6298

© 2005 EOS Technologies, Inc.
Tucson, AZ USA

THIS DOCUMENT & ENCLOSED INFORMATION
REMAINS THE PROPERTY OF EOS
TECHNOLOGIES INC. INTELLECTUAL
PROPERTY AND INFORMATION HEREIN MAY
NOT BE COPIED NOR DISCLOSED WITHOUT
WRITTEN CONSENT OF EOS TECHNOLOGIES,
INC. MANAGEMENT.

FILE C:\GGay\Lick Schematics\SCH-5376-4 APF Cabinet Cable Schematics TEMPlencp1powerW002.SCHDOC
PRINTED 12/8/2009 4:07:35 PM
TEMPLATE: Eost_tabloid_SUBS

EOS Technologies, Inc.

3160 E. TRANSCON WAY, Suite 180
TUCSON, ARIZONA 85706 USA

TITLE

LICK APF ENCP1 Power

DOCUMENT NUMBER

SCH-5376-4

SIZE

A3

EastConfig SCH-5376-4

SHEET 12 OF 64

I/O BUS ENCP_0 to ENCP_1

Label:
P16_ENCP_0
W014
to J16_ENCP_0
CARD

Label:
W014

Label:
P15_ENCP_1
W014
to J15_ENCP_1
CARD

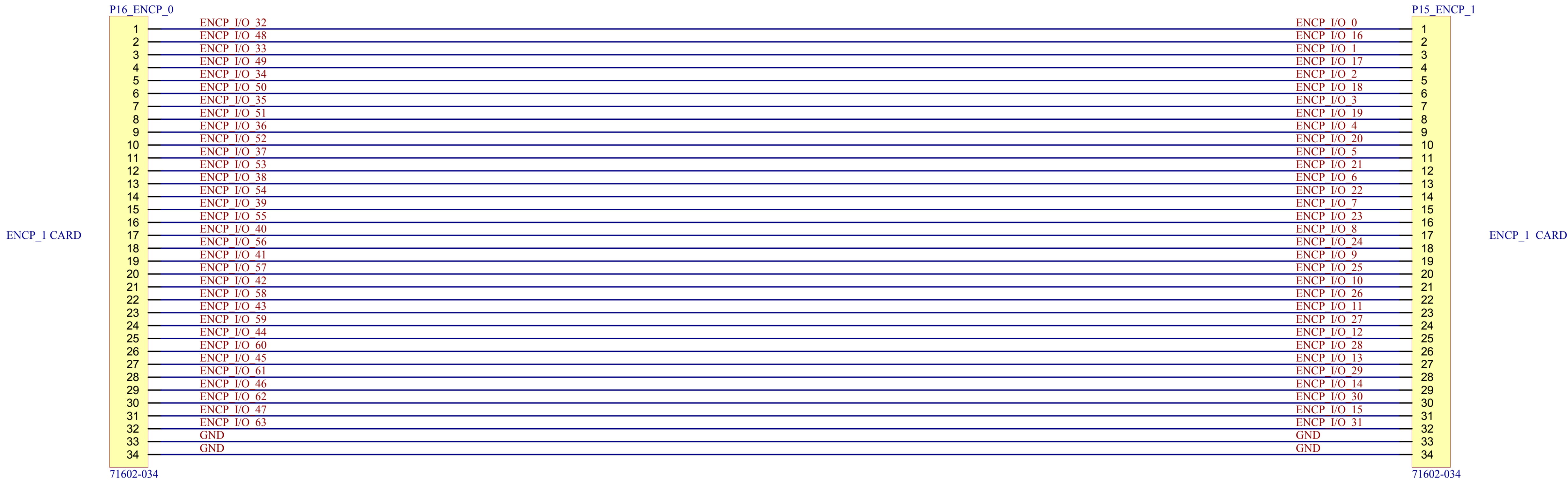

WIRE TYPE: 34 Conductor Ribbon Cable
LENGTH: 20"

© 2005 EOS Technologies, Inc.
Tucson, AZ USA

THIS DOCUMENT & ENCLOSED INFORMATION
REMAINS THE PROPERTY OF EOS
TECHNOLOGIES INC. INTELLECTUAL
PROPERTY AND INFORMATION HEREIN MAY
NOT BE COPIED NOR DISCLOSED WITHOUT
WRITTEN CONSENT OF EOS TECHNOLOGIES,
INC. MANAGEMENT.

FILE C:\GGay\Lick Schematics\SCH-5376-4 APF Cabinet Cable Schematics TEMPlencncpW014.SCHDOC
PRINTED 12/8/2009 4:07:36 PM
TEMPLATE: Eost_tabloid_SUBS

EOS Technologies, Inc.

3160 E. TRANSCON WAY, Suite 180
TUCSON, ARIZONA 85706 USA

TITLE

LICK APF ENCP0 to ENCP1 Interface

DOCUMENT NUMBER

SCH-5376-4

SIZE

A3

EastConfig SCH-5376-4

SHEET 16 OF 64

SECONDARY_A, B, C

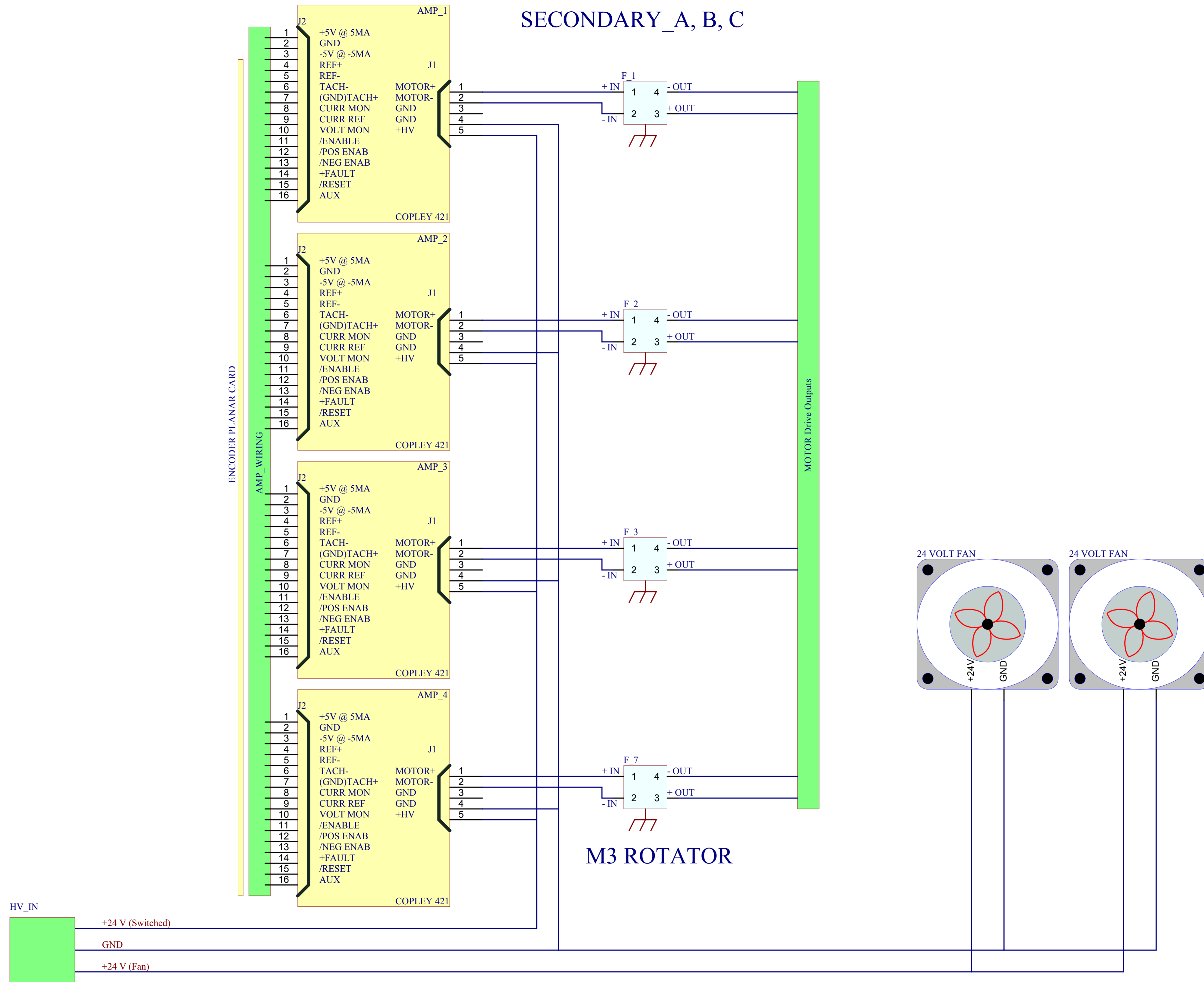

© 2005 EOS Technologies, Inc.
Tucson, AZ USA

THIS DOCUMENT & ENCLOSED INFORMATION
REMAINS THE PROPERTY OF EOS
TECHNOLOGIES INC. INTELLECTUAL
PROPERTY AND INFORMATION HEREIN MAY
NOT BE COPIED NOR DISCLOSED WITHOUT
WRITTEN CONSENT OF EOS TECHNOLOGIES,
INC. MANAGEMENT.

FILE C:\GGay\Lick Schematics\SCH-5376-4 APF Cabinet Cable Schematics TEMP\ENCP_0_SCHDOC
PRINTED 12/8/2009 4:07:36 PM
TEMPLATE: Eost_tabloid_SUBS

EOS Technologies, Inc.

3160 E. TRANSCON WAY, Suite 180
TUCSON, ARIZONA 85706 USA

TITLE

LICK APF ENCP0 Block Diagram

DOCUMENT NUMBER

SCH-5376-4

SIZE

A3

EastConfig

SCH-5376-4

SHEET 5 OF 64

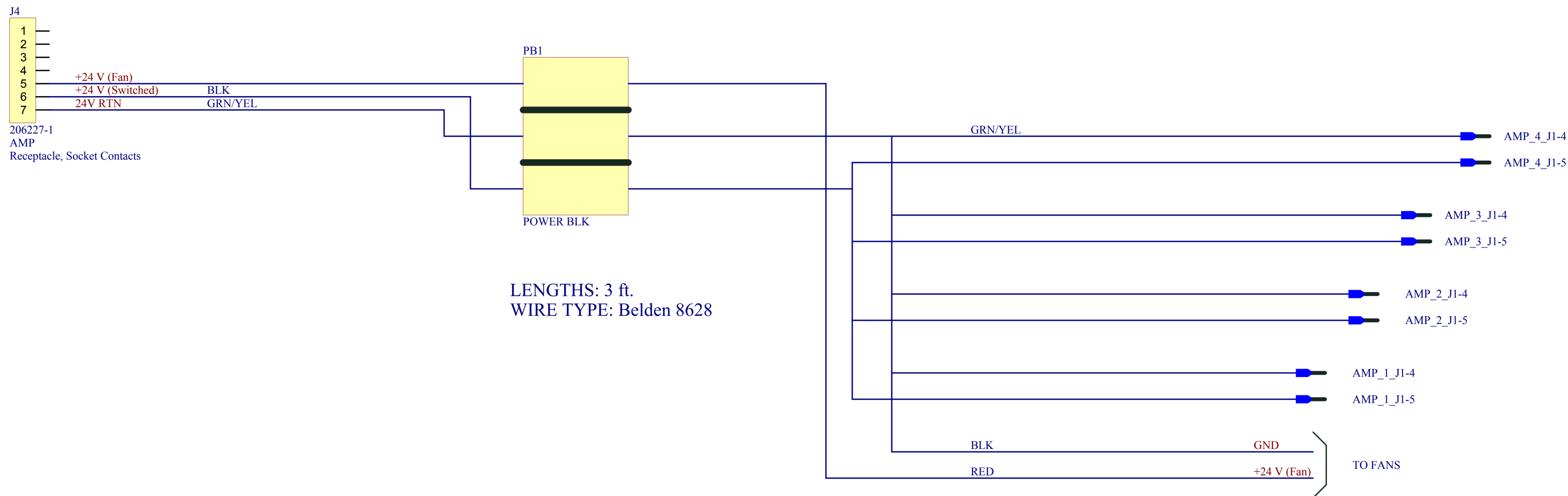

© 2005 EOS Technologies, Inc.
Tucson, AZ USA

THIS DOCUMENT & ENCLOSED INFORMATION
REMAINS THE PROPERTY OF EOS
TECHNOLOGIES INC. INTELLECTUAL
PROPERTY AND INFORMATION HEREIN MAY
NOT BE COPIED NOR DISCLOSED WITHOUT
WRITTEN CONSENT OF EOS TECHNOLOGIES,
INC. MANAGEMENT.

FILE C:\GGay\Lick Schematics\SCH-5376-4 APF Cabinet Cable Schematics TEMP\HV_IN.SCHDOC
PRINTED 12/8/2009 4:07:37 PM
TEMPLATE: Eost_tabloid_SUBS

EOS Technologies, Inc.

3160 E. TRANSCON WAY, Suite 180
TUCSON, ARIZONA 85706 USA

TITLE

LICK APF ENCP0 Voltage Input

DOCUMENT NUMBER

SCH-5376-4

SIZE

A3

EastConfig SCH-5376-4

SHEET 4 OF 64

LICK APF ENCP0 Voltage Input
SCH-5376-4

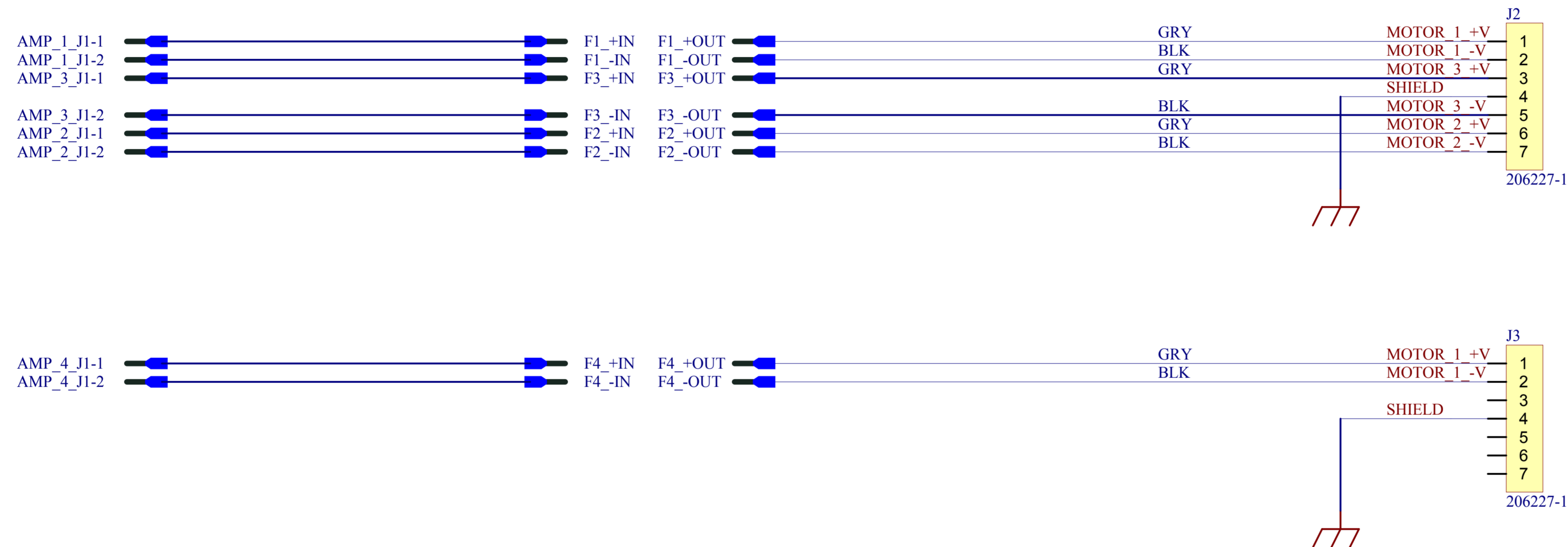

LENGTHS: 0.6M

© 2005 EOS Technologies, Inc.
Tucson, AZ USA

THIS DOCUMENT & ENCLOSED INFORMATION
REMAINS THE PROPERTY OF EOS
TECHNOLOGIES INC. INTELLECTUAL
PROPERTY AND INFORMATION HEREIN MAY
NOT BE COPIED NOR DISCLOSED WITHOUT
WRITTEN CONSENT OF EOS TECHNOLOGIES,
INC. MANAGEMENT.

FILE C:\GGay\Lick Schematics\SCH-5376-4 APF Cabinet Cable Schematics TEMP\MOTOR_OUT.SCHDOC
PRINTED 12/8/2009 4:07:38 PM
TEMPLATE: Eost_tabloid_SUBS

EOS Technologies, Inc.

3160 E. TRANSCON WAY, Suite 180
TUCSON, ARIZONA 85706 USA

TITLE

LICK APF ENCP0 Motor Drive Outputs

DOCUMENT NUMBER

SCH-5376-4

SIZE

A3

EastConfig

SCH-5376-4

SHEET 7

OF

64

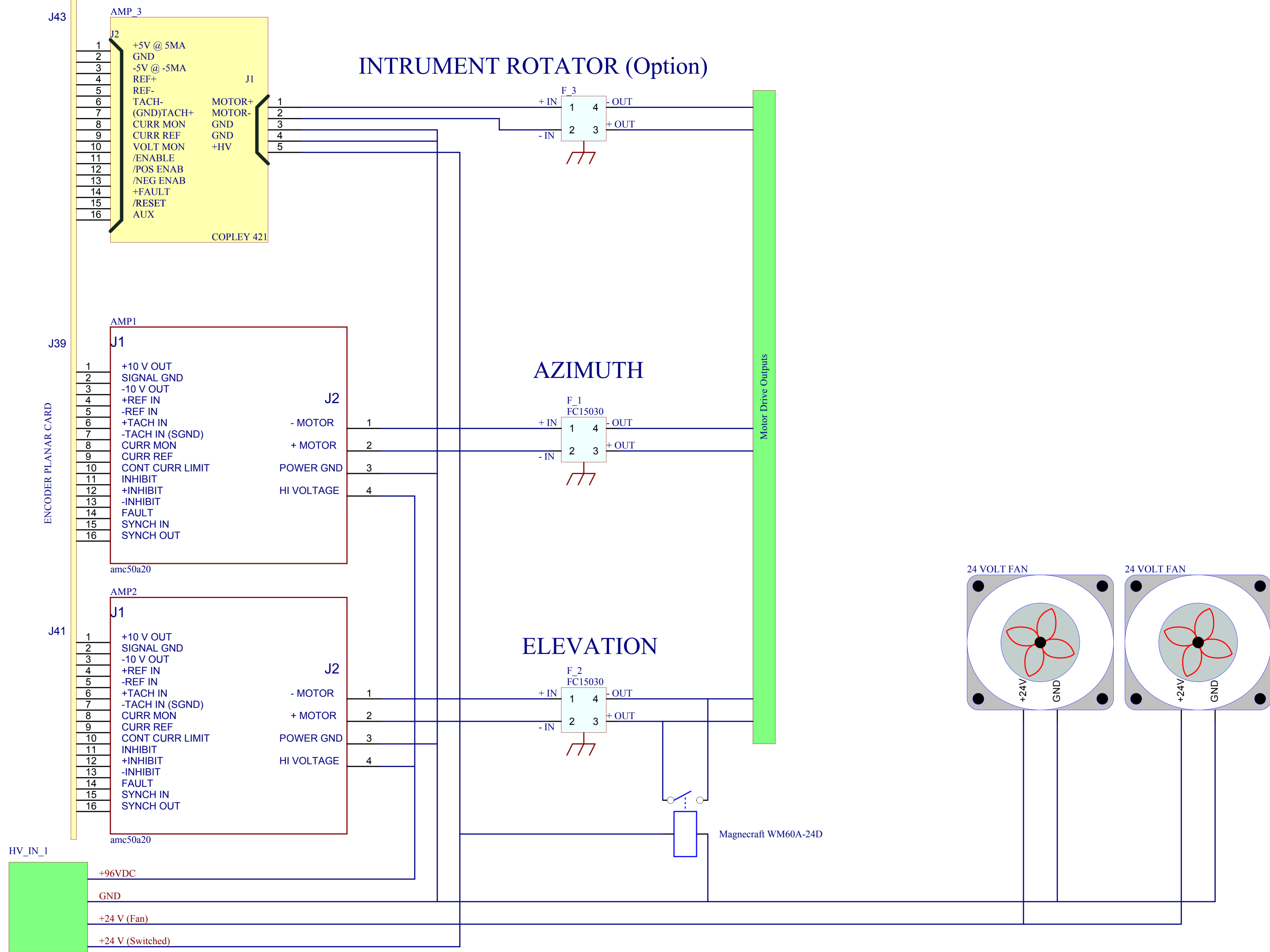

© 2005 EOS Technologies, Inc.
Tucson, AZ USA

THIS DOCUMENT & ENCLOSED INFORMATION
REMAINS THE PROPERTY OF EOS
TECHNOLOGIES INC. INTELLECTUAL
PROPERTY AND INFORMATION HEREIN MAY
NOT BE COPIED NOR DISCLOSED WITHOUT
WRITTEN CONSENT OF EOS TECHNOLOGIES,
INC. MANAGEMENT.

FILE C:\GGay\Lick Schematics\SCH-5376-4 APF Cabinet Cable Schematics TEMP\ENCP_1.SCHDOC
PRINTED 12/8/2009 4:07:39 PM
TEMPLATE: Eost_tabloid_SUBS

EOS Technologies, Inc.

3160 E. TRANSCON WAY, Suite 180
TUCSON, ARIZONA 85706 USA

TITLE

LICK APF ENCP1 Block Diagram

DOCUMENT NUMBER

SCH-5376-4

SIZE

A3

EastConfig SCH-5376-4

SHEET 9 OF 64

EXTERNAL ESTOP

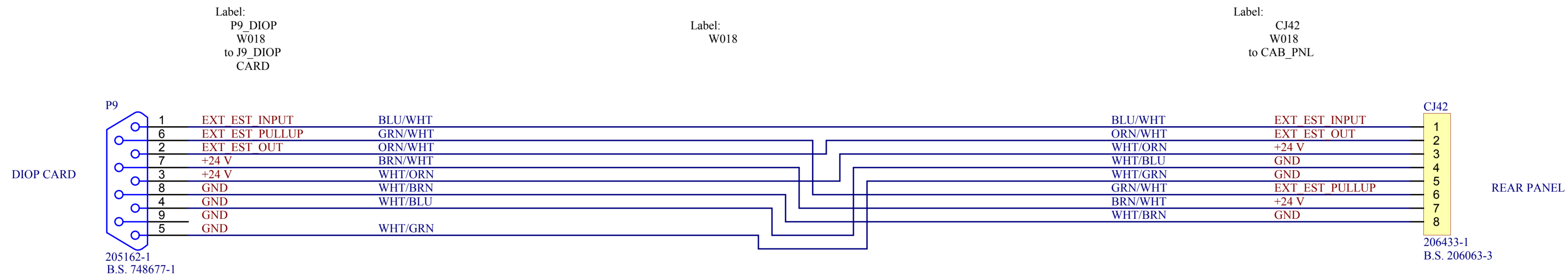

WIRE TYPE: BELDEN 1421A
 LENGTH: 60"

© 2005 EOS Technologies, Inc.
 Tucson, AZ USA

THIS DOCUMENT & ENCLOSED INFORMATION
 REMAINS THE PROPERTY OF EOS
 TECHNOLOGIES INC. INTELLECTUAL
 PROPERTY AND INFORMATION HEREIN MAY
 NOT BE COPIED NOR DISCLOSED WITHOUT
 WRITTEN CONSENT OF EOS TECHNOLOGIES,
 INC. MANAGEMENT.

FILE C:\GGay\Lick Schematics\SCH-5376-4 APF Cabinet Cable Schematics TEMPl'estopW018.SCHDOC
 PRINTED 12/8/2009 4:07:40 PM
 TEMPLATE: Eost_tabloid_SUBS

EOS Technologies, Inc.

3160 E. TRANSCON WAY, Suite 180
 TUCSON, ARIZONA 85706 USA

TITLE

APF TCC Emergency Stop Interface

DOCUMENT NUMBER

SCH-5376-4

SIZE

A3

EostConfig

SCH-5376-4

SHEET 60 OF

64

FRONT PANEL I/O CABLE

FRONT PANEL

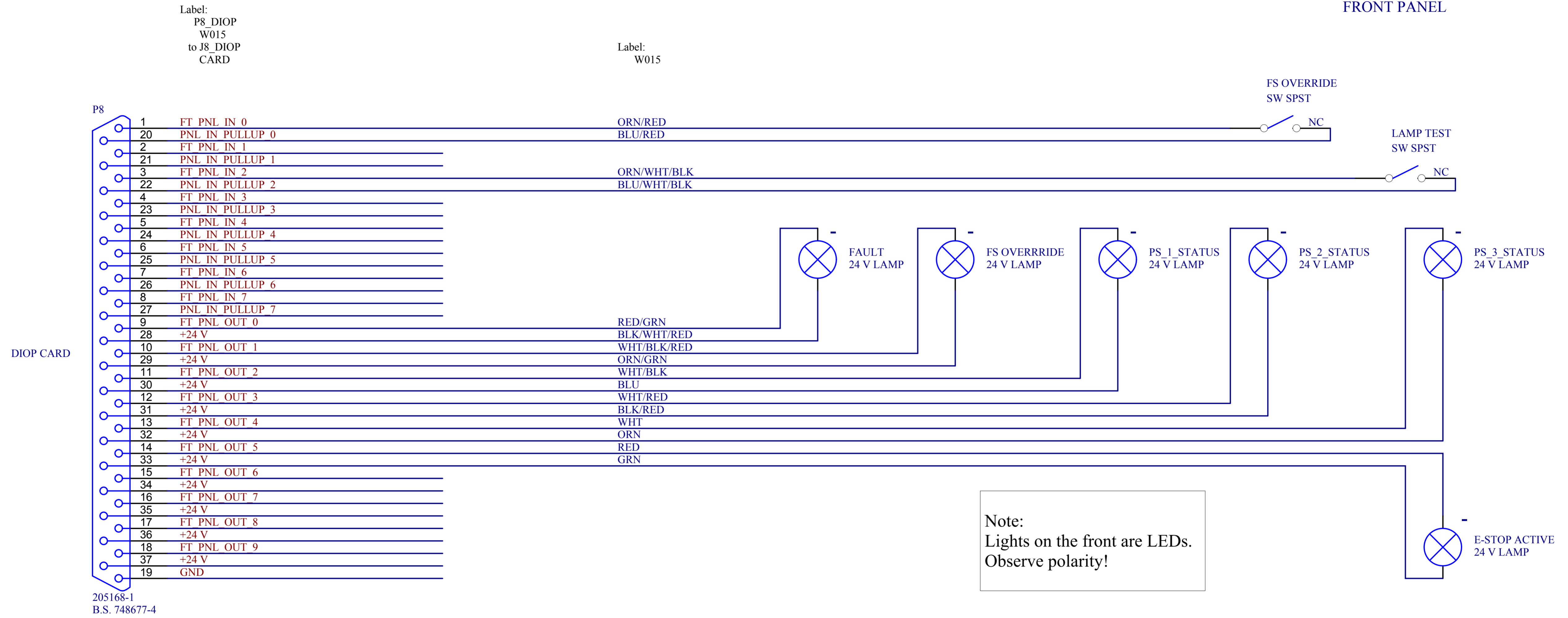

WIRE TYPE: ALPHA 6348
LENGTH: 80"

Note:
Lights on the front are LEDs.
Observe polarity!

© 2005 EOS Technologies, Inc.
Tucson, AZ USA

THIS DOCUMENT & ENCLOSED INFORMATION
REMAINS THE PROPERTY OF EOS
TECHNOLOGIES INC. INTELLECTUAL
PROPERTY AND INFORMATION HEREIN MAY
NOT BE COPIED NOR DISCLOSED WITHOUT
WRITTEN CONSENT OF EOS TECHNOLOGIES,
INC. MANAGEMENT.

FILE C:\GGay\Lick Schematics\SCH-5376-4 APF Cabinet Cable Schematics TEMP\fpnlW015.SCHDOC
PRINTED 12/8/2009 4:07:40 PM
TEMPLATE: Eost_tabloid_SUBS

EOS Technologies, Inc.

3160 E. TRANSCON WAY, Suite 180
TUCSON, ARIZONA 85706 USA

TITLE

LICK APF Front Panel Interconnects

DOCUMENT NUMBER

SCH-5376-4

SIZE

A3

EastConfig

SCH-5376-4

SHEET 25 OF 64

1 2 3 4 5 6 7 8

D

D

C

C

B

B

A

A

TCC GND. BAR
GROUNDING BOLT

TCC BACK PANEL
GROUNDING BOLT

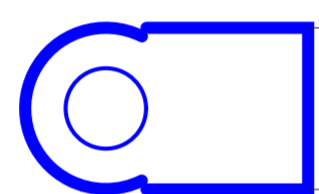

RINGTERM_LG (NEWARK P/N 84F292)
LABEL:
W017
TELESCOPE
GND
TCC GND BAR

LABEL:
W017

RINGTERM_LG (NEWARK P/N 84F292)
LABEL:
W017
TELESCOPE
GND
TCC PNL BOLT

WIRE TYPE: CAROLPRENE 2GA. WELDING CABLE
LENGTH: 30 In.

© 2005 EOS Technologies, Inc.
Tucson, AZ USA

THIS DOCUMENT & ENCLOSED INFORMATION
REMAINS THE PROPERTY OF EOS
TECHNOLOGIES INC. INTELLECTUAL
PROPERTY AND INFORMATION HEREIN MAY
NOT BE COPIED NOR DISCLOSED WITHOUT
WRITTEN CONSENT OF EOS TECHNOLOGIES,
INC. MANAGEMENT.

FILE C:\GGay\Lick Schematics\SCH-5376-4 APF Cabinet Cable Schematics TEMP\gndW017.SCHDOC
PRINTED 12/8/2009 4:07:41 PM
TEMPLATE: Eost_tabloid_SUBS

EOS Technologies, Inc.

3160 E. TRANSCON WAY, Suite 180
TUCSON, ARIZONA 85706 USA

TITLE

APF Cabinet Grounding Connection

DOCUMENT NUMBER

SCH-5376-4

SIZE

A3

EastConfig

SCH-5376-4

SHEET 62

OF

64

1 2 3 4 5 6 7 8

SCH-5376-4 APF Cabinet Grounding Connection

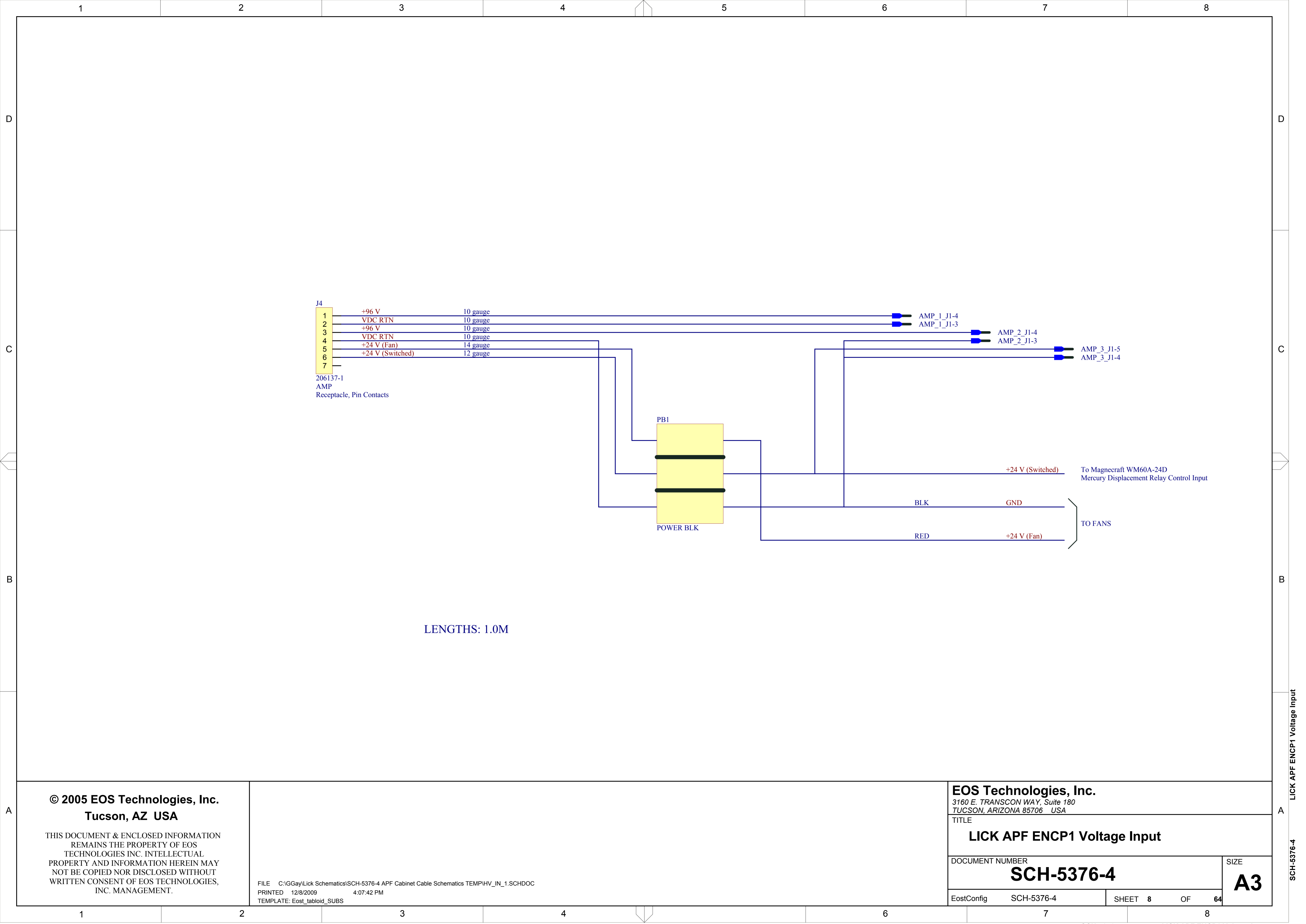

LENGTHS: 1.0M

© 2005 EOS Technologies, Inc.
Tucson, AZ USA

THIS DOCUMENT & ENCLOSED INFORMATION
REMAINS THE PROPERTY OF EOS
TECHNOLOGIES INC. INTELLECTUAL
PROPERTY AND INFORMATION HEREIN MAY
NOT BE COPIED NOR DISCLOSED WITHOUT
WRITTEN CONSENT OF EOS TECHNOLOGIES,
INC. MANAGEMENT.

FILE C:\GGay\Lick Schematics\SCH-5376-4 APF Cabinet Cable Schematics TEMP\HV_IN_1.SCHDOC
PRINTED 12/8/2009 4:07:42 PM
TEMPLATE: Eost_tabloid_SUBS

EOS Technologies, Inc.
3160 E. TRANSCON WAY, Suite 180
TUCSON, ARIZONA 85706 USA

TITLE
LICK APF ENCP1 Voltage Input

DOCUMENT NUMBER
SCH-5376-4 SIZE
A3

EostConfig SCH-5376-4 SHEET 8 OF 64

LICK APF ENCP1 Voltage Input
SCH-5376-4

PMAC J3JTHW CONNECTING CABLE

Label:
P3JTHW
W009
to J3JTHW
PMAC_A

Label:
W009

Label:
P17_ENC0_0
W009
to J17_ENC0_0

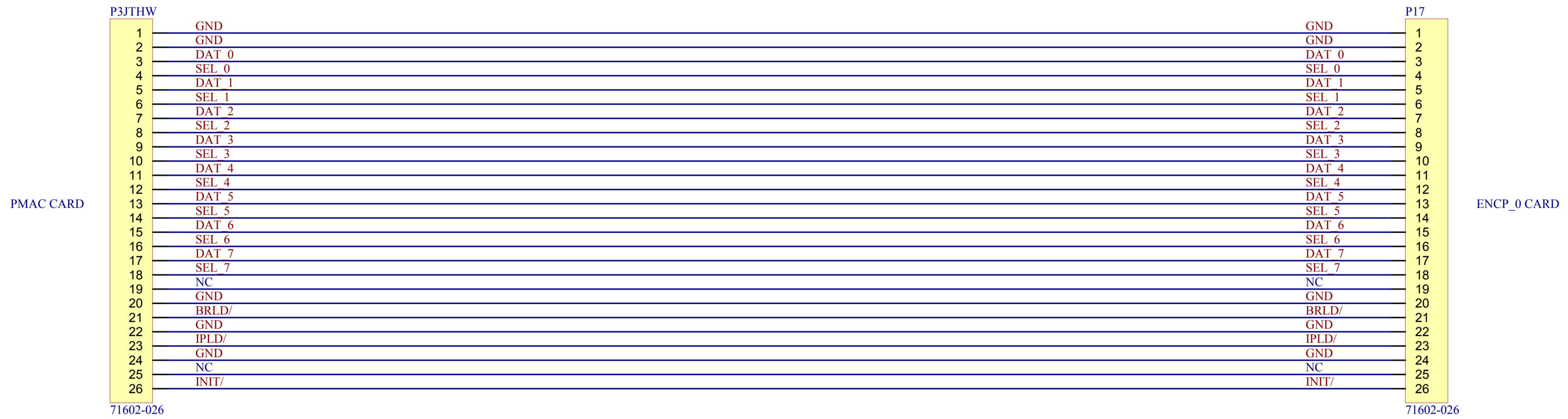

26 CONDUCTOR RIBBON CABLE
LENGTH: 44"

© 2005 EOS Technologies, Inc.
Tucson, AZ USA

THIS DOCUMENT & ENCLOSED INFORMATION
REMAINS THE PROPERTY OF EOS
TECHNOLOGIES INC. INTELLECTUAL
PROPERTY AND INFORMATION HEREIN MAY
NOT BE COPIED NOR DISCLOSED WITHOUT
WRITTEN CONSENT OF EOS TECHNOLOGIES,
INC. MANAGEMENT.

FILE C:\GGay\Lick Schematics\SCH-5376-4 APF Cabinet Cable Schematics TEMP\j3jthwW009.SCHDOC
PRINTED 12/8/2009 4:07:43 PM
TEMPLATE: Eost_tabloid_SUBS

EOS Technologies, Inc.

3160 E. TRANSCON WAY, Suite 180
TUCSON, ARIZONA 85706 USA

TITLE

LICK APF PMAC DAT/SEL Interface

DOCUMENT NUMBER

SCH-5376-4

SIZE

A3

EastConfig SCH-5376-4

SHEET 22 OF 64

PMAC J5JOPT CONNECTING CABLE

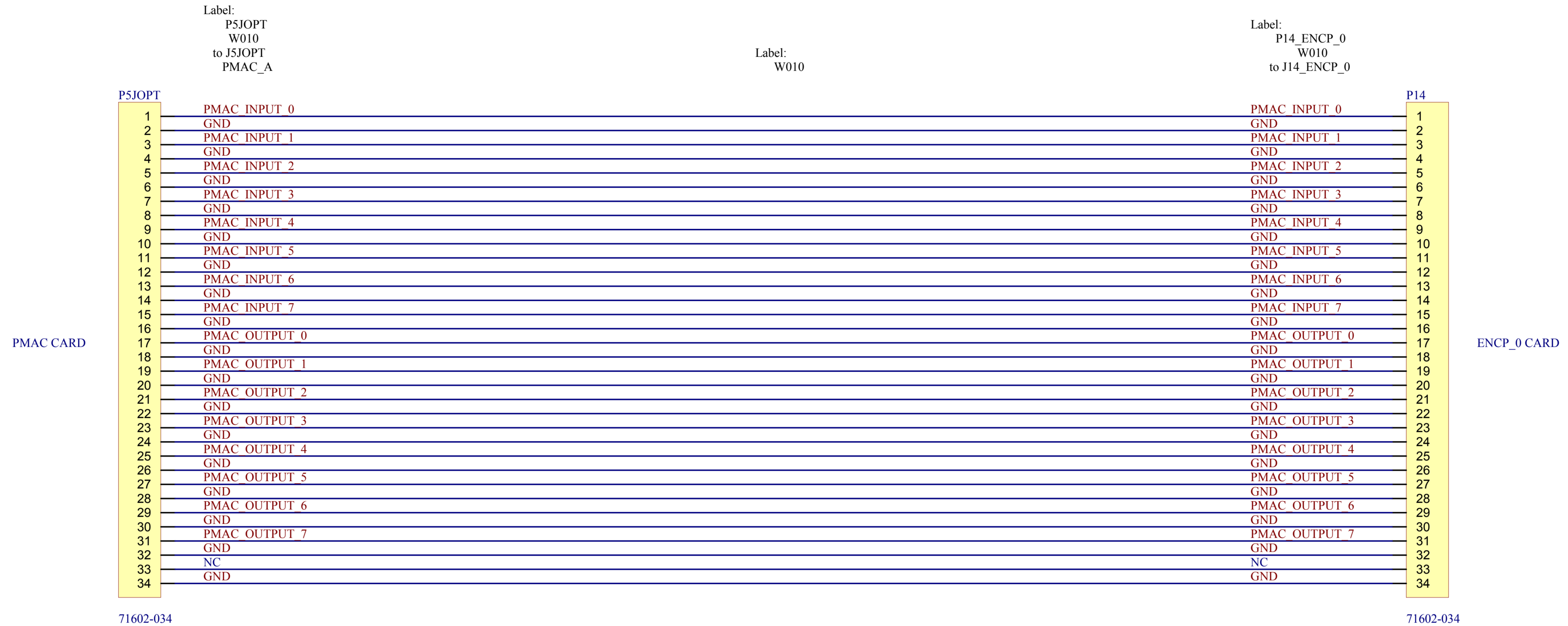

34 CONDUCTOR RIBBON CABLE
LENGTHS: 42"

© 2005 EOS Technologies, Inc.
Tucson, AZ USA

THIS DOCUMENT & ENCLOSED INFORMATION
REMAINS THE PROPERTY OF EOS
TECHNOLOGIES INC. INTELLECTUAL
PROPERTY AND INFORMATION HEREIN MAY
NOT BE COPIED NOR DISCLOSED WITHOUT
WRITTEN CONSENT OF EOS TECHNOLOGIES,
INC. MANAGEMENT.

FILE C:\GGay\Lick Schematics\SCH-5376-4 APF Cabinet Cable Schematics TEMP\j5joptW010.SCHDOC
PRINTED 12/8/2009 4:07:44 PM
TEMPLATE: Eost_tabloid_SUBS

EOS Technologies, Inc.

3160 E. TRANSCON WAY, Suite 180
TUCSON, ARIZONA 85706 USA

TITLE

LICK APF PMAC Machine IO Interface

DOCUMENT NUMBER

SCH-5376-4

SIZE

A3

EastConfig

SCH-5376-4

SHEET 23 OF 64

MOUSE EXTENSION CABLE

LABEL:
W053
MOUSE
PORT_TCC

LABEL:
W053

LABEL:
W053
to KVM_SW

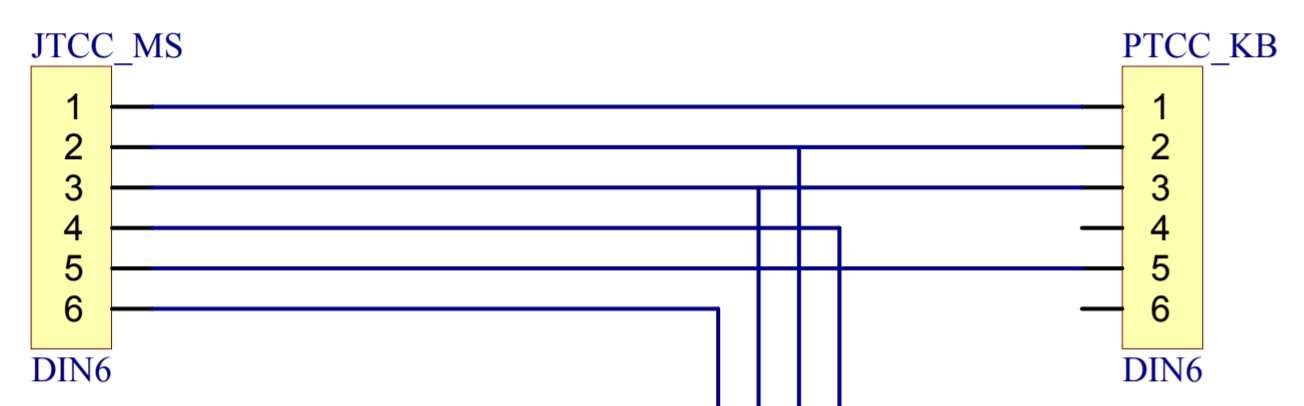
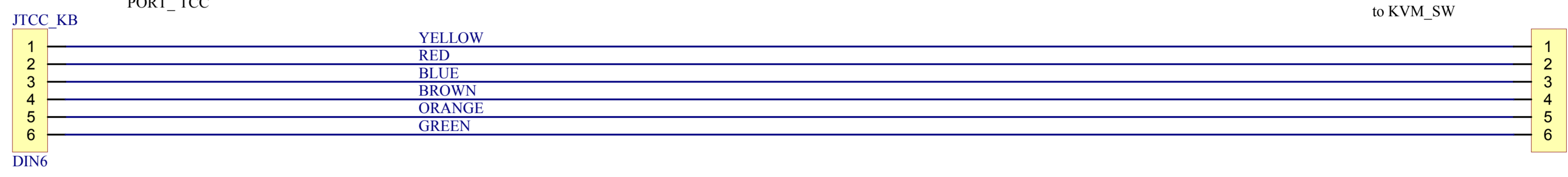

NOTE:
This "Off the Shelf" cable connects both keyboard and mouse to a single DIN connector on the computer.

KEYBOARD EXTENSION CABLE

LABEL:
W052
KYBD
PORT_TCC

LABEL:
W052

LABEL:
W052
to KVM_SW

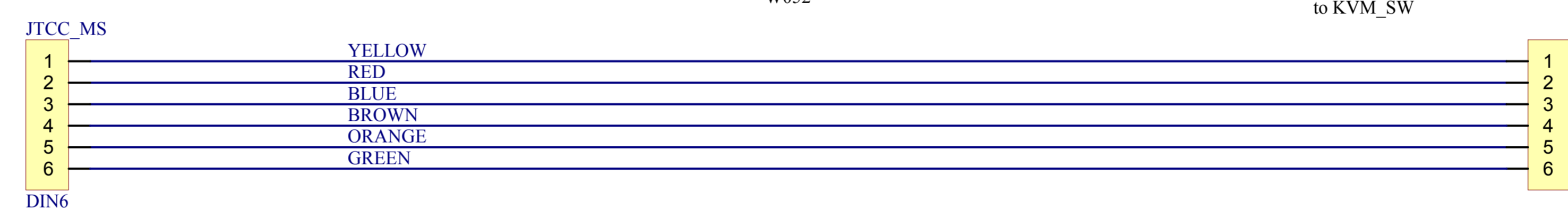

LENGTH: 48"
WIRE TYPE: OTS DIN CABLES

© 2005 EOS Technologies, Inc.
Tucson, AZ USA

THIS DOCUMENT & ENCLOSED INFORMATION REMAINS THE PROPERTY OF EOS TECHNOLOGIES INC. INTELLECTUAL PROPERTY AND INFORMATION HEREIN MAY NOT BE COPIED NOR DISCLOSED WITHOUT WRITTEN CONSENT OF EOS TECHNOLOGIES, INC. MANAGEMENT.

FILE C:\GGay\Lick Schematics\SCH-5376-4 APF Cabinet Cable Schematics TEMP\kybd_mouseW052_W053.SCHDOC
PRINTED 12/8/2009 4:07:45 PM
TEMPLATE: Eost_tabloid_SUBS

EOS Technologies, Inc.
3160 E. TRANSCON WAY, Suite 180
TUCSON, ARIZONA 85706 USA

TITLE
APF Keyboard/Mouse Extension Cable

DOCUMENT NUMBER
SCH-5376-4

SIZE
A3

EastConfig SCH-5376-4 SHEET 27 OF 64

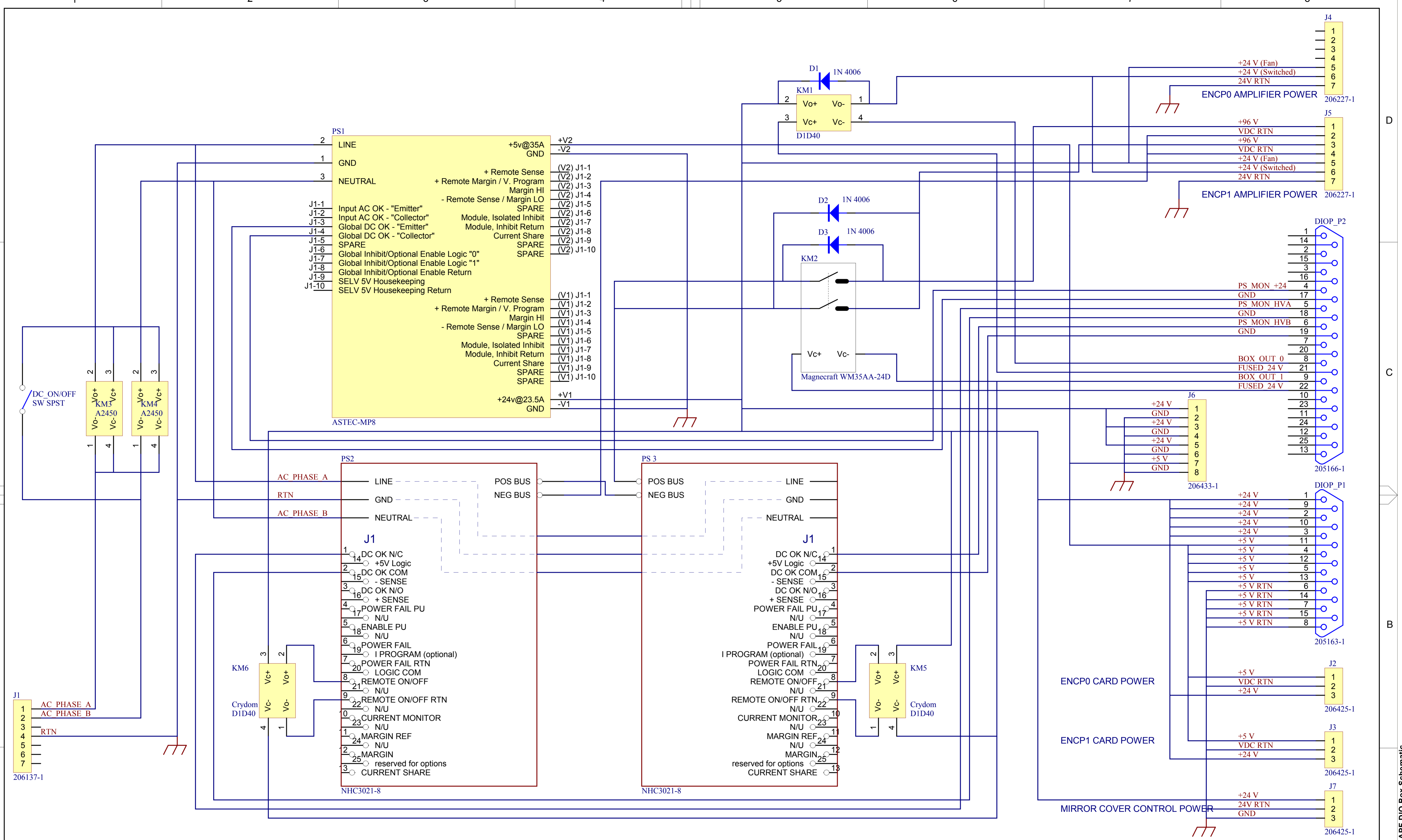

© 2005 EOS Technologies, Inc.
Tucson, AZ USA

THIS DOCUMENT & ENCLOSED INFORMATION
REMAINS THE PROPERTY OF EOS
TECHNOLOGIES INC. INTELLECTUAL
PROPERTY AND INFORMATION HEREIN MAY
NOT BE COPIED NOR DISCLOSED WITHOUT
WRITTEN CONSENT OF EOS TECHNOLOGIES,
INC. MANAGEMENT.

FILE C:\GGay\Lick Schematics\SCH-5376-4 APF Cabinet Cable Schematics TEMP\Lick_APF_DIOBOX.SCHDOC
PRINTED 12/8/2009 4:07:46 PM
TEMPLATE: Eost_tabloid_SUBS

EOS Technologies, Inc.

3160 E. TRANSCON WAY, Suite 180
TUCSON, ARIZONA 85706 USA

TITLE

LICK APF DIO Box Schematic

DOCUMENT NUMBER

SCH-5376-4

SIZE

A3

EastConfig SCH-5376-4

SHEET 2 OF 64

LICK APF DIO Box Schematic
SCH-5376-4

Label:
P2_ENCP_0
W020
to J2_ENCP_0
CARD

Label:
W020

Label:
CJ5
W020
to CAB_PNL

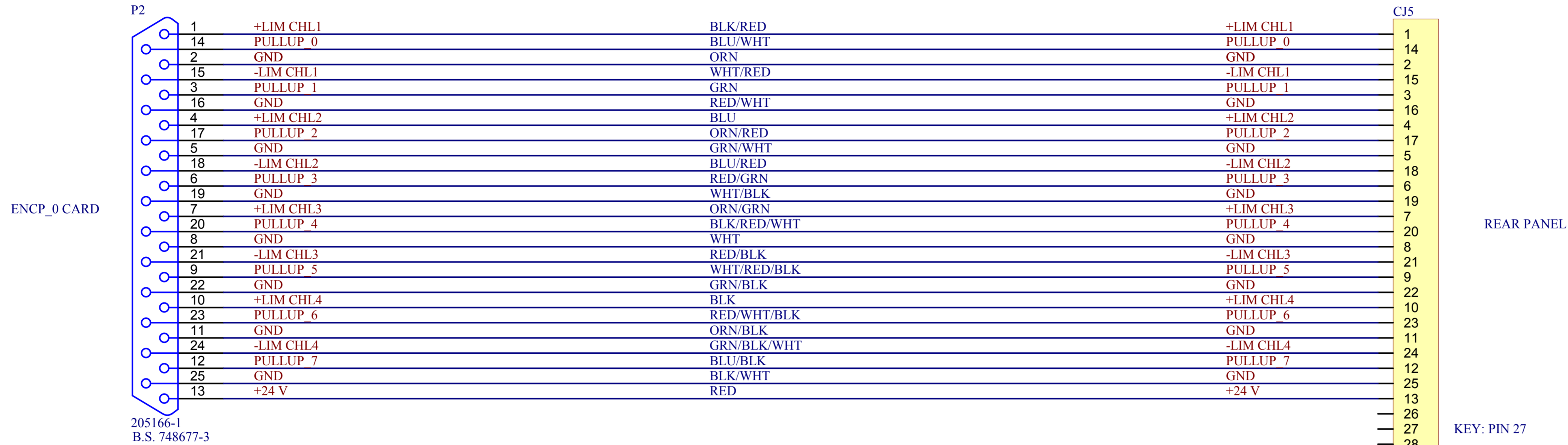

WIRE TYPE: ALPHA 6348
LENGTH: 66"

SECONDARY LIMIT INPUTS
PMAC LIMIT INPUTS [1..4]

© 2005 EOS Technologies, Inc.
Tucson, AZ USA

THIS DOCUMENT & ENCLOSED INFORMATION
REMAINS THE PROPERTY OF EOS
TECHNOLOGIES INC. INTELLECTUAL
PROPERTY AND INFORMATION HEREIN MAY
NOT BE COPIED NOR DISCLOSED WITHOUT
WRITTEN CONSENT OF EOS TECHNOLOGIES,
INC. MANAGEMENT.

FILE C:\GGay\Lick Schematics\SCH-5376-4 APF Cabinet Cable Schematics TEMP\M2 Limits_W020.SCHDOC
PRINTED 12/8/2009 4:07:46 PM
TEMPLATE: Eost_tabloid_SUBS

EOS Technologies, Inc.

3160 E. TRANSCON WAY, Suite 180
TUCSON, ARIZONA 85706 USA

TITLE

APF M2 End of Travel Limits

DOCUMENT NUMBER

SCH-5376-4

SIZE

A3

EastConfig

SCH-5376-4

SHEET 34

OF 64

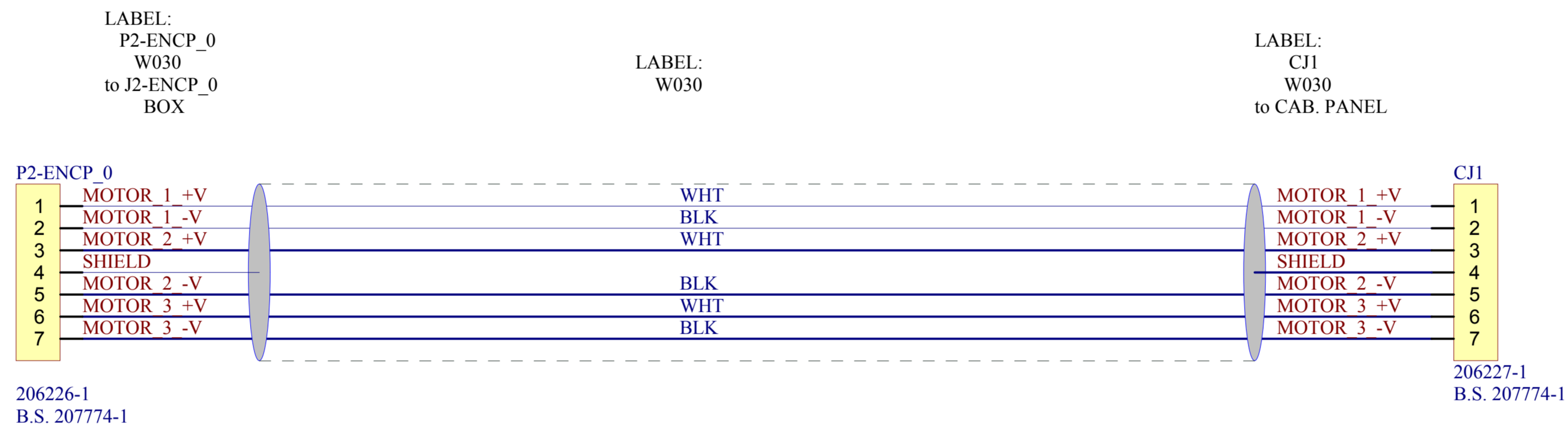

SECONDARY MOTOR DRIVE

LENGTHS: 68"
 WIRE TYPE: PVAZBD6298

© 2005 EOS Technologies, Inc.
 Tucson, AZ USA

THIS DOCUMENT & ENCLOSED INFORMATION
 REMAINS THE PROPERTY OF EOS
 TECHNOLOGIES INC. INTELLECTUAL
 PROPERTY AND INFORMATION HEREIN MAY
 NOT BE COPIED NOR DISCLOSED WITHOUT
 WRITTEN CONSENT OF EOS TECHNOLOGIES,
 INC. MANAGEMENT.

FILE C:\GGay\Lick Schematics\SCH-5376-4 APF Cabinet Cable Schematics TEMP\m2drvW030.SCHDOC
 PRINTED 12/8/2009 4:07:47 PM
 TEMPLATE: Eost_tabloid_SUBS

EOS Technologies, Inc.

3160 E. TRANSCON WAY, Suite 180
 TUCSON, ARIZONA 85706 USA

TITLE

APF M2 Actuator Drives

DOCUMENT NUMBER

SCH-5376-4

SIZE

A3

EostConfig SCH-5376-4

SHEET 33 OF 64

D

D

C

C

B

B

A

A

Label:
P12_DIOP
W021
to J12_DIOP
CARD

Label:
W021

Label:
CJ6
W021
to CAB_PNL

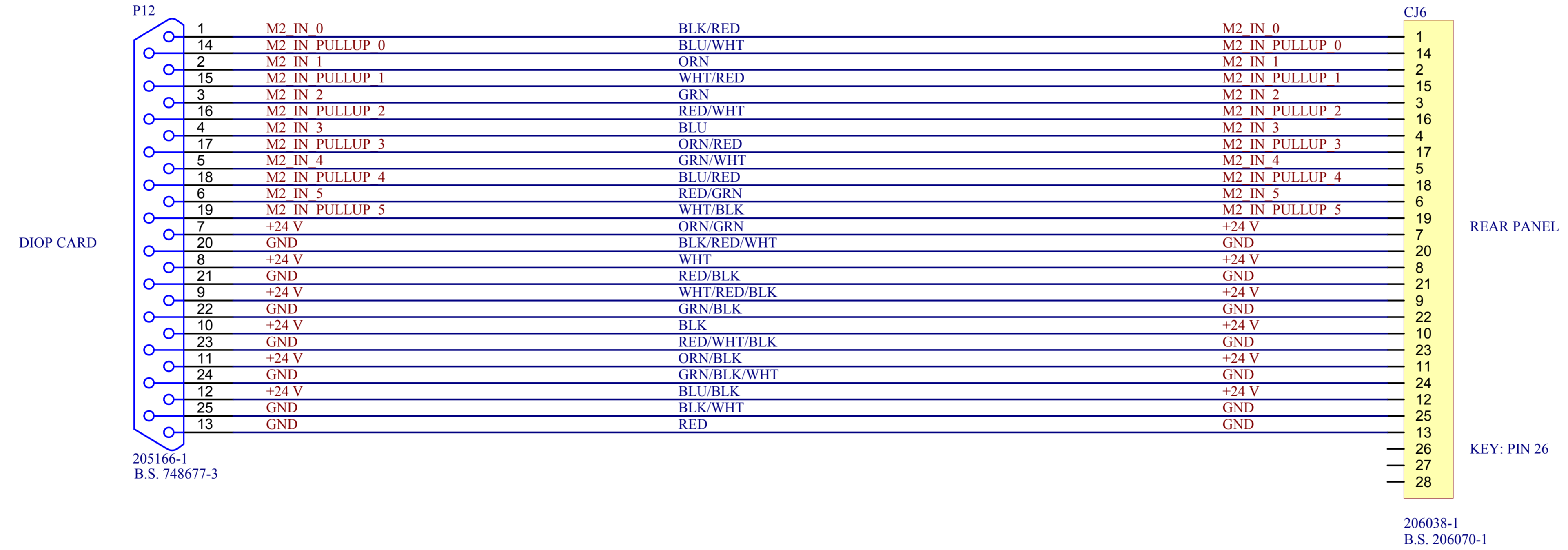

WIRE TYPE: ALPHA 6348
LENGTH: 48.5"

M2 FAILSAFE I/O

© 2005 EOS Technologies, Inc.
Tucson, AZ USA

THIS DOCUMENT & ENCLOSED INFORMATION
REMAINS THE PROPERTY OF EOS
TECHNOLOGIES INC. INTELLECTUAL
PROPERTY AND INFORMATION HEREIN MAY
NOT BE COPIED NOR DISCLOSED WITHOUT
WRITTEN CONSENT OF EOS TECHNOLOGIES,
INC. MANAGEMENT.

FILE C:\GGay\Lick Schematics\SCH-5376-4 APF Cabinet Cable Schematics TEMP\m2fsw021.SCHDOC
PRINTED 12/8/2009 4:07:48 PM
TEMPLATE: Eost_tabloid_SUBS

EOS Technologies, Inc.
3160 E. TRANSCON WAY, Suite 180
TUCSON, ARIZONA 85706 USA

TITLE	
APF M2 Failsafe Limits	
DOCUMENT NUMBER	SIZE
SCH-5376-4	A3
EastConfig SCH-5376-4	SHEET 35 OF 64

APF M2 Failsafe Limits
SCH-5376-4

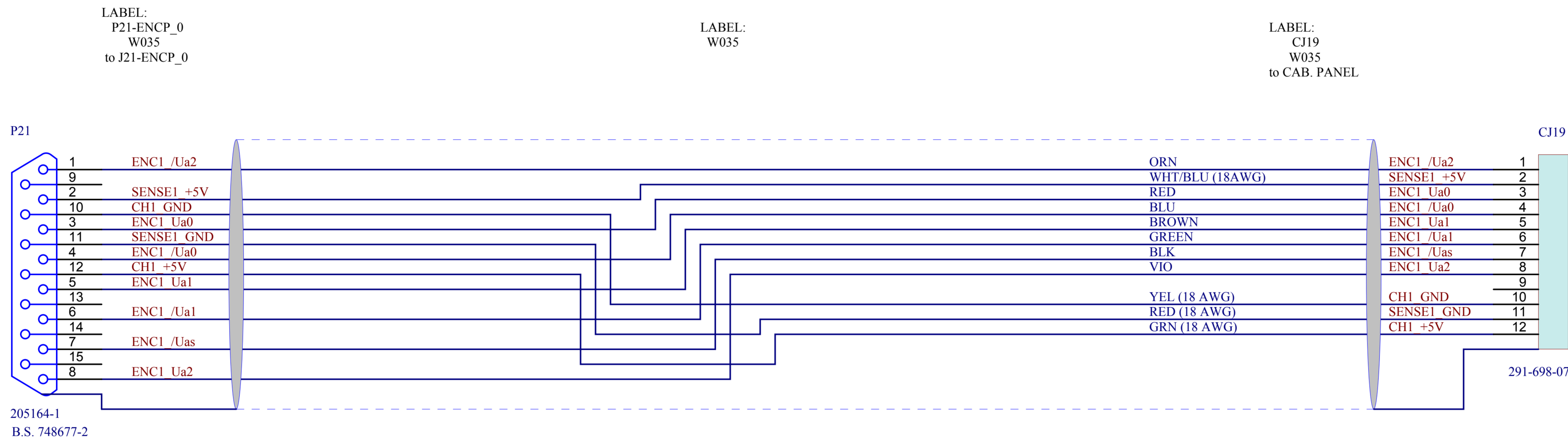

LENGTHS: 60 in.
 WIRE TYPE: PETSCHÉ OR HEIDENHAIN 244-957-01

THE SHIELD OF THIS CABLE WAS CONNECTED TO THE METAL CASE OF THE CONNECTOR DURING CABLE ASSEMBLY FABRICATION

© 2005 EOS Technologies, Inc.
 Tucson, AZ USA

THIS DOCUMENT & ENCLOSED INFORMATION REMAINS THE PROPERTY OF EOS TECHNOLOGIES INC. INTELLECTUAL PROPERTY AND INFORMATION HEREIN MAY NOT BE COPIED NOR DISCLOSED WITHOUT WRITTEN CONSENT OF EOS TECHNOLOGIES, INC. MANAGEMENT.

FILE C:\GGay\Lick Schematics\SCH-5376-4 APF Cabinet Cable Schematics TEMP\m2linenc\W035.SCHDOC
 PRINTED 12/8/2009 4:07:49 PM
 TEMPLATE: Eost_tabloid_SUBS

EOS Technologies, Inc.

3160 E. TRANSCON WAY, Suite 180
 TUCSON, ARIZONA 85706 USA

TITLE

APF M2 Linear Encoder A

DOCUMENT NUMBER

SCH-5376-4

SIZE

A3

EastConfig SCH-5376-4

SHEET 37 OF 64

LABEL:
P22-ENCP_0
W036
to J22-ENCP_0

LABEL:
W036

LABEL:
CJ20
W036
to CAB. PANEL

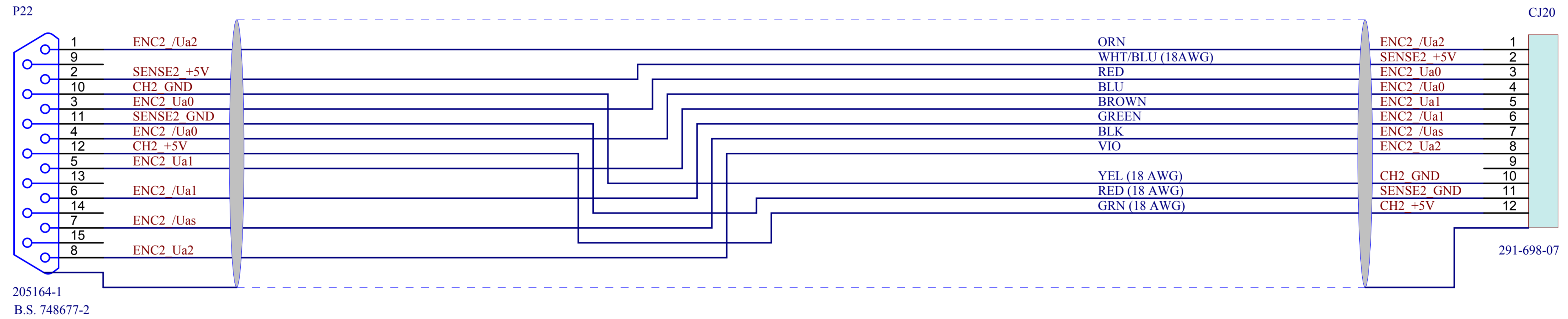

THE SHIELD OF THIS CABLE WAS CONNECTED TO THE METAL CASE OF THE CONNECTOR DURING CABLE ASSEMBLY FABRICATION

LENGTHS: 60 in.
WIRE TYPE: PETSCHKE OR HEIDENHAIN 244-957-01

© 2005 EOS Technologies, Inc.
Tucson, AZ USA

THIS DOCUMENT & ENCLOSED INFORMATION REMAINS THE PROPERTY OF EOS TECHNOLOGIES INC. INTELLECTUAL PROPERTY AND INFORMATION HEREIN MAY NOT BE COPIED NOR DISCLOSED WITHOUT WRITTEN CONSENT OF EOS TECHNOLOGIES, INC. MANAGEMENT.

FILE C:\GGay\Lick Schematics\SCH-5376-4 APF Cabinet Cable Schematics TEMP\m2linencW036.SCHDOC
PRINTED 12/8/2009 4:07:50 PM
TEMPLATE: Eost_tabloid_SUBS

EOS Technologies, Inc.
3160 E. TRANSCON WAY, Suite 180
TUCSON, ARIZONA 85706 USA

TITLE
APF M2 Linear Encoder B

DOCUMENT NUMBER
SCH-5376-4

SIZE
A3

EastConfig SCH-5376-4 SHEET 38 OF 64

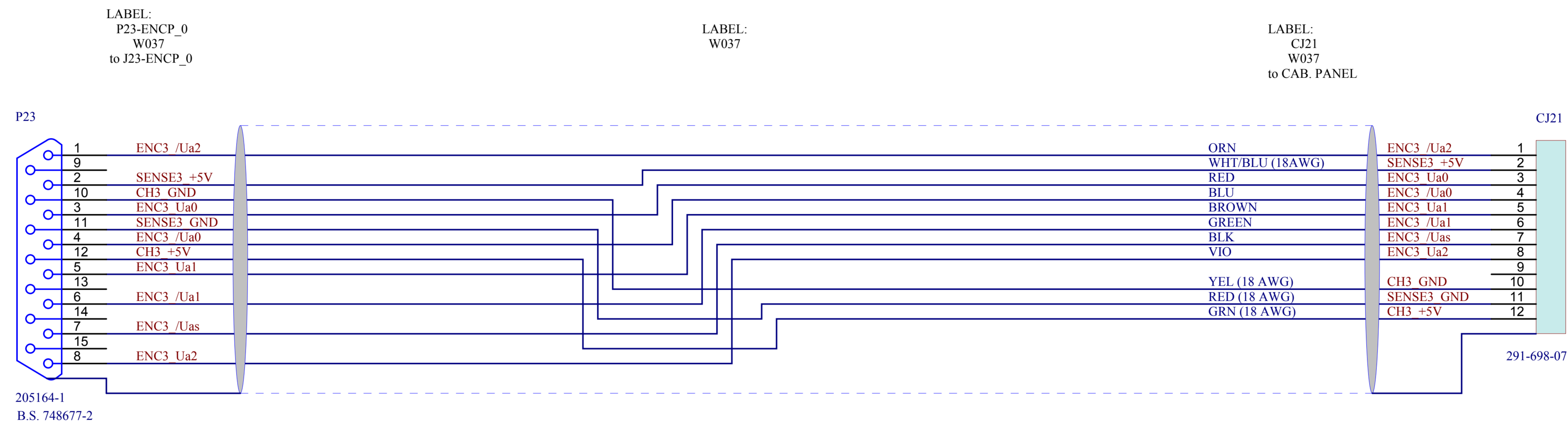

THE SHIELD OF THIS CABLE WAS CONNECTED TO THE METAL CASE OF THE CONNECTOR DURING CABLE ASSEMBLY FABRICATION

LENGTHS: 60 in.
WIRE TYPE: PETSCHÉ OR HEIDENHAIN 244-957-01

© 2005 EOS Technologies, Inc.
Tucson, AZ USA

THIS DOCUMENT & ENCLOSED INFORMATION REMAINS THE PROPERTY OF EOS TECHNOLOGIES INC. INTELLECTUAL PROPERTY AND INFORMATION HEREIN MAY NOT BE COPIED NOR DISCLOSED WITHOUT WRITTEN CONSENT OF EOS TECHNOLOGIES, INC. MANAGEMENT.

FILE C:\GGay\Lick Schematics\SCH-5376-4 APF Cabinet Cable Schematics TEMP\m2linenc\W037.SCHDOC
PRINTED 12/8/2009 4:07:50 PM
TEMPLATE: Eost_tabloid_SUBS

EOS Technologies, Inc.
3160 E. TRANSCON WAY, Suite 180
TUCSON, ARIZONA 85706 USA

TITLE
APF M2 Linear Encoder C

DOCUMENT NUMBER	SIZE
SCH-5376-4	A3
EostConfig SCH-5376-4	SHEET 39 OF 64

D

D

C

C

B

B

A

A

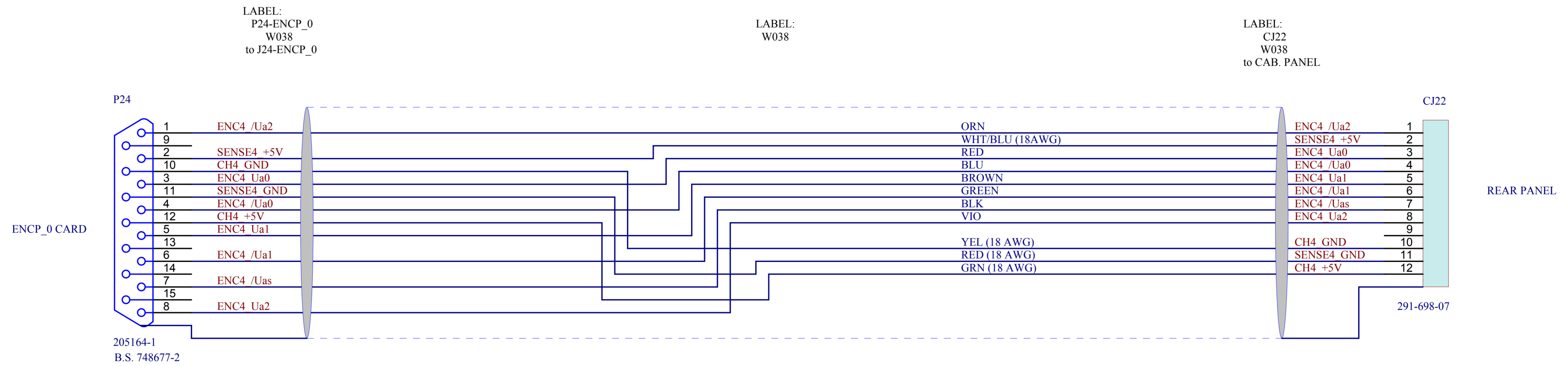

LENGTHS: 60 in.
 WIRE TYPE: PETSCHER OR HEIDENHAIN 244-957-01

© 2005 EOS Technologies, Inc.
 Tucson, AZ USA

THIS DOCUMENT & ENCLOSED INFORMATION
 REMAINS THE PROPERTY OF EOS
 TECHNOLOGIES INC. INTELLECTUAL
 PROPERTY AND INFORMATION HEREIN MAY
 NOT BE COPIED NOR DISCLOSED WITHOUT
 WRITTEN CONSENT OF EOS TECHNOLOGIES,
 INC. MANAGEMENT.

FILE C:\GGay\Lick Schematics\SCH-5376-4 APF Cabinet Cable Schematics TEMP\m2motencW038.SCHDOC
 PRINTED 12/8/2009 4:07:51 PM
 TEMPLATE: Eost_tabloid_SUBS

EOS Technologies, Inc.
 3160 E. TRANSCON WAY, Suite 180
 TUCSON, ARIZONA 85706 USA

TITLE
APF M2 Motor Encoder A

DOCUMENT NUMBER	SCH-5376-4	SIZE	A3
EostConfig	SCH-5376-4	SHEET 40 OF 64	

APF M2 Motor Encoder A
SCH-5376-4

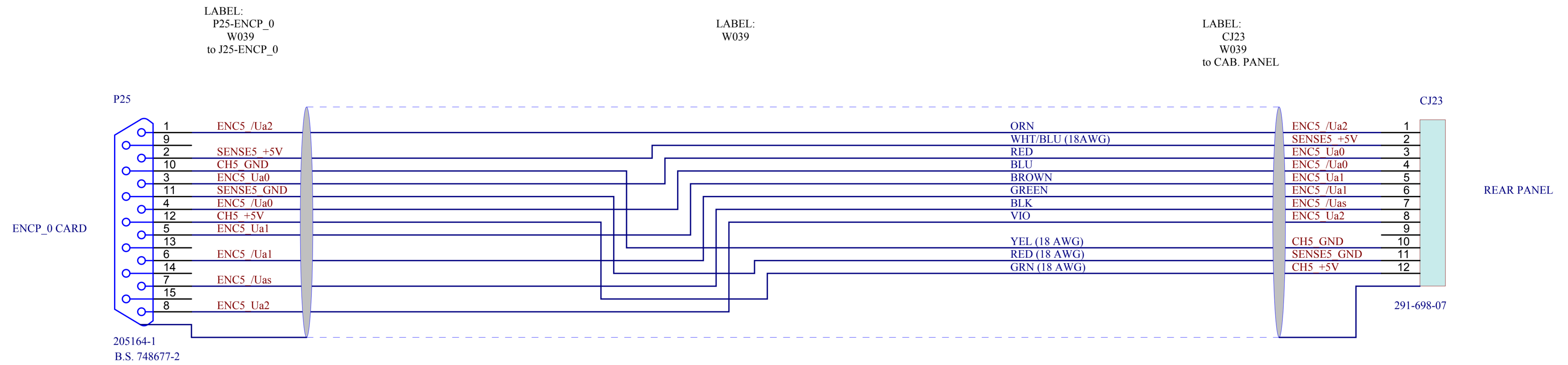

LENGTHS: 60 in.
WIRE TYPE: PETSCHKE OR HEIDENHAIN 244-957-01

© 2005 EOS Technologies, Inc.
Tucson, AZ USA

THIS DOCUMENT & ENCLOSED INFORMATION
REMAINS THE PROPERTY OF EOS
TECHNOLOGIES INC. INTELLECTUAL
PROPERTY AND INFORMATION HEREIN MAY
NOT BE COPIED NOR DISCLOSED WITHOUT
WRITTEN CONSENT OF EOS TECHNOLOGIES,
INC. MANAGEMENT.

FILE C:\GGay\Lick Schematics\SCH-5376-4 APF Cabinet Cable Schematics TEMP\m2motencW039.SCHDOC
PRINTED 12/8/2009 4:07:52 PM
TEMPLATE: Eost_tabloid_SUBS

EOS Technologies, Inc.

3160 E. TRANSCON WAY, Suite 180
TUCSON, ARIZONA 85706 USA

TITLE

APF M2 Motor Encoder B

DOCUMENT NUMBER

SCH-5376-4

SIZE

A3

EastConfig SCH-5376-4

SHEET 41 OF 64

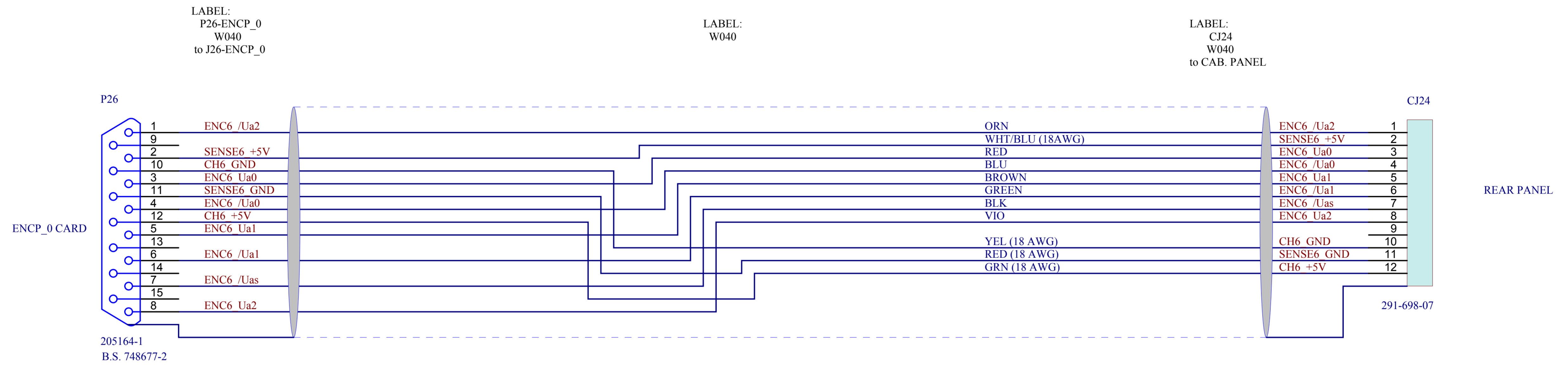

LENGTHS: 60 in.
WIRE TYPE: PETSCHKE OR HEIDENHAIN 244-957-01

THE SHIELD OF THIS CABLE WAS CONNECTED TO THE METAL CASE OF THE CONNECTOR DURING CABLE ASSEMBLY FABRICATION

© 2005 EOS Technologies, Inc.
Tucson, AZ USA

THIS DOCUMENT & ENCLOSED INFORMATION REMAINS THE PROPERTY OF EOS TECHNOLOGIES INC. INTELLECTUAL PROPERTY AND INFORMATION HEREIN MAY NOT BE COPIED NOR DISCLOSED WITHOUT WRITTEN CONSENT OF EOS TECHNOLOGIES, INC. MANAGEMENT.

FILE C:\GGay\Lick Schematics\SCH-5376-4 APF Cabinet Cable Schematics TEMP\m2motencW040.SCHDOC
PRINTED 12/8/2009 4:07:53 PM
TEMPLATE: Eost_tabloid_SUBS

EOS Technologies, Inc.

3160 E. TRANSCON WAY, Suite 180
TUCSON, ARIZONA 85706 USA

TITLE

APF M2 Motor Encoder C

DOCUMENT NUMBER

SCH-5376-4

SIZE

A3

EastConfig

SCH-5376-4

SHEET 42 OF 64

M2 TILT F.S.

Label:
P13_DIOP
W022
to J13_DIOP
CARD

Label:
W022

Label:
CJ7
W022
to CAB_PNL



WIRE TYPE: ALPHA 6348
LENGTH: 72.75"

© 2005 EOS Technologies, Inc.
Tucson, AZ USA

THIS DOCUMENT & ENCLOSED INFORMATION
REMAINS THE PROPERTY OF EOS
TECHNOLOGIES INC. INTELLECTUAL
PROPERTY AND INFORMATION HEREIN MAY
NOT BE COPIED NOR DISCLOSED WITHOUT
WRITTEN CONSENT OF EOS TECHNOLOGIES,
INC. MANAGEMENT.

FILE C:\GGay\Lick Schematics\SCH-5376-4 APF Cabinet Cable Schematics TEMP\m2tilt\W022.SCHDOC
PRINTED 12/8/2009 4:07:54 PM
TEMPLATE: Eost_tabloid_SUBS

EOS Technologies, Inc.

3160 E. TRANSCON WAY, Suite 180
TUCSON, ARIZONA 85706 USA

TITLE

APF M2 Failsafe Tilt Limits

DOCUMENT NUMBER

SCH-5376-4

SIZE

A3

EastConfig SCH-5376-4

SHEET 36 OF 64

M3 ROTATOR MOTOR DRIVE

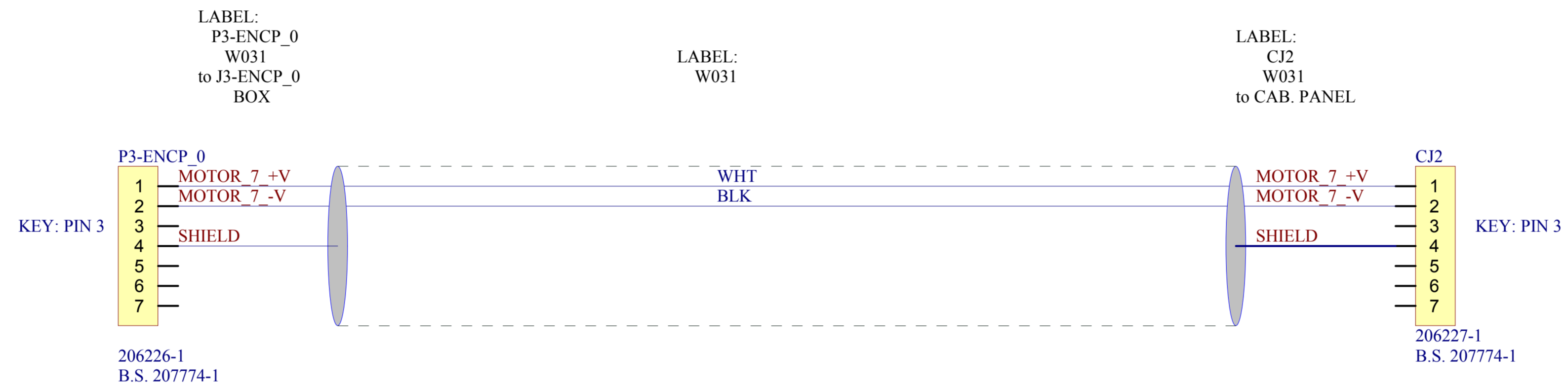

LENGTHS: 68"
WIRE TYPE: BELDEN 8718

© 2005 EOS Technologies, Inc.
Tucson, AZ USA

THIS DOCUMENT & ENCLOSED INFORMATION
REMAINS THE PROPERTY OF EOS
TECHNOLOGIES INC. INTELLECTUAL
PROPERTY AND INFORMATION HEREIN MAY
NOT BE COPIED NOR DISCLOSED WITHOUT
WRITTEN CONSENT OF EOS TECHNOLOGIES,
INC. MANAGEMENT.

FILE C:\GGay\Lick Schematics\SCH-5376-4 APF Cabinet Cable Schematics TEMP\m3drvW031.SCHDOC
PRINTED 12/8/2009 4:07:54 PM
TEMPLATE: Eost_tabloid_SUBS

EOS Technologies, Inc.

3160 E. TRANSCON WAY, Suite 180
TUCSON, ARIZONA 85706 USA

TITLE

APF M3 Rotator Drive

DOCUMENT NUMBER

SCH-5376-4

SIZE

A3

EastConfig SCH-5376-4

SHEET 30 OF 64

D

D

C

C

B

B

A

A

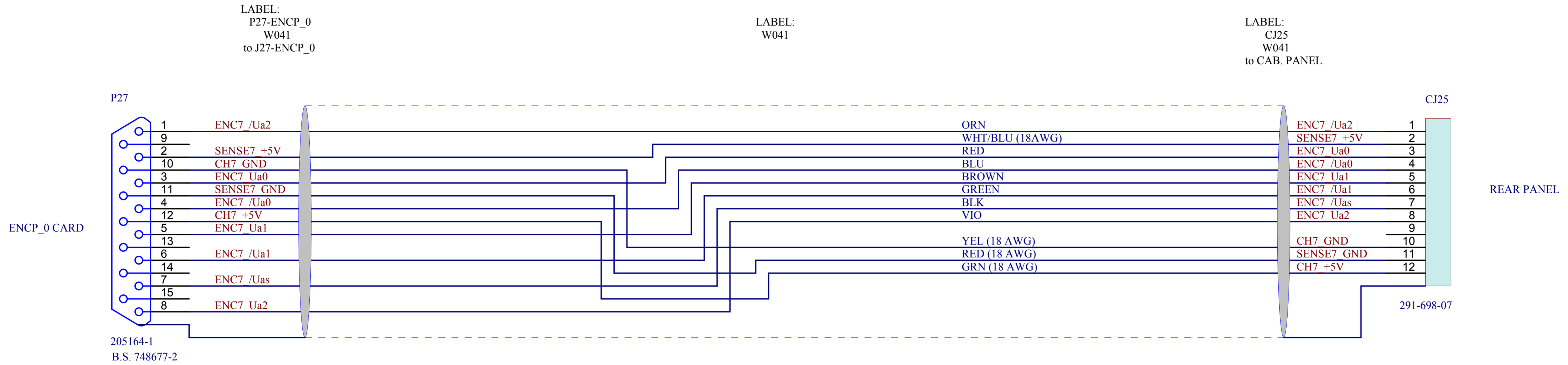

LABEL:
P27-ENCP_0
W041
to J27-ENCP_0

LABEL:
W041

LABEL:
CJ25
W041
to CAB. PANEL

ENC_P_0 CARD

P27

CJ25

205164-1
B.S. 748677-2

291-698-07

REAR PANEL

THE SHIELD OF THIS CABLE WAS CONNECTED
TO THE METAL CASE OF THE CONNECTOR
DURING CABLE ASSEMBLY FABRICATION

LENGTHS: 60 in.
WIRE TYPE: PETSCHKE OR HEIDENHAIN 244-957-01

© 2005 EOS Technologies, Inc.
Tucson, AZ USA

THIS DOCUMENT & ENCLOSED INFORMATION
REMAINS THE PROPERTY OF EOS
TECHNOLOGIES INC. INTELLECTUAL
PROPERTY AND INFORMATION HEREIN MAY
NOT BE COPIED NOR DISCLOSED WITHOUT
WRITTEN CONSENT OF EOS TECHNOLOGIES,
INC. MANAGEMENT.

FILE C:\GGay\Lick Schematics\SCH-5376-4 APF Cabinet Cable Schematics TEMP\M3encW041.SCHDOC
PRINTED 12/8/2009 4:07:55 PM
TEMPLATE: Eost_tabloid_SUBS

EOS Technologies, Inc.
3160 E. TRANSCON WAY, Suite 180
TUCSON, ARIZONA 85706 USA

TITLE
APF M3 Rotator Encoder

DOCUMENT NUMBER
SCH-5376-4

SIZE
A3

EastConfig SCH-5376-4 SHEET 32 OF 64

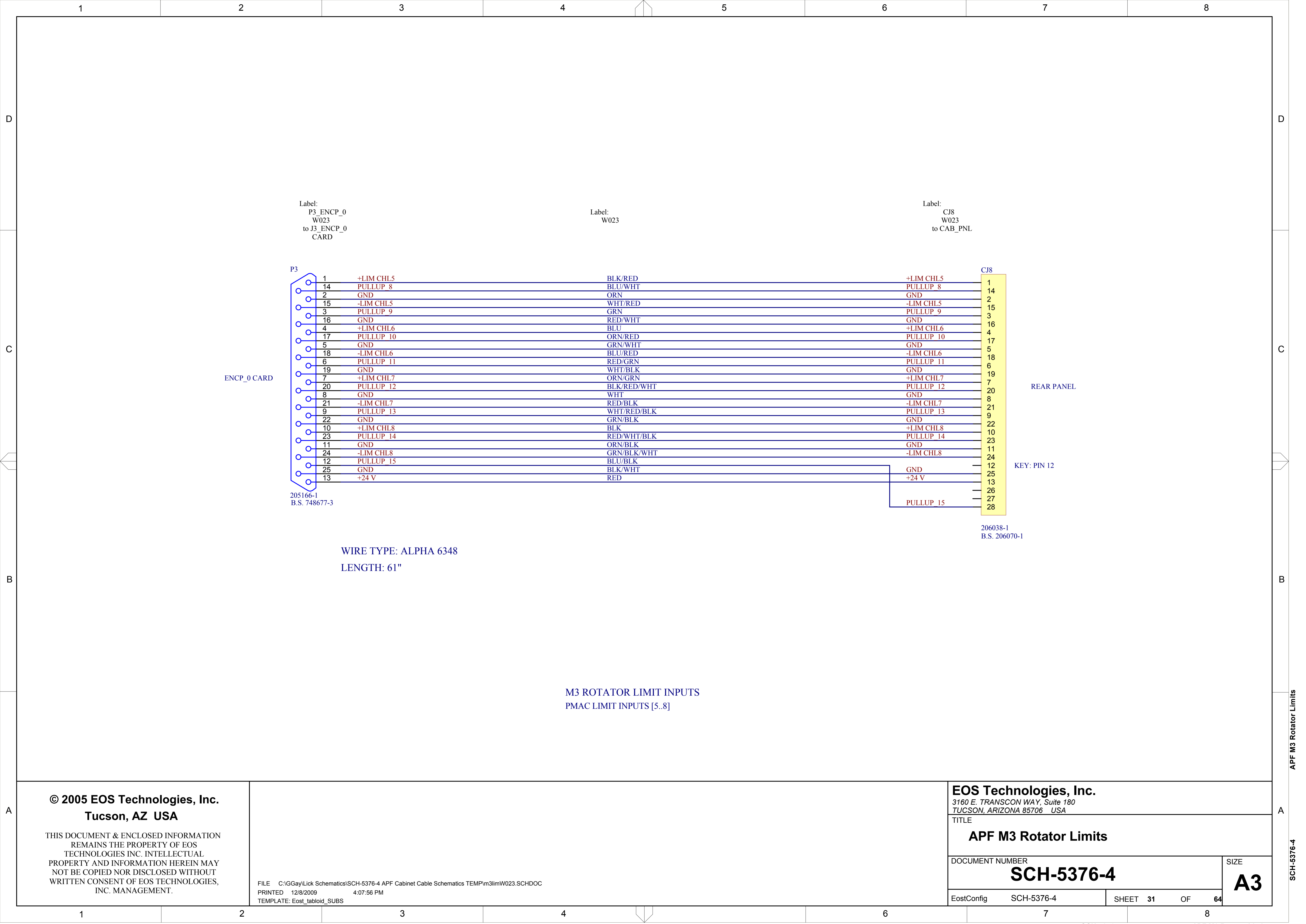

© 2005 EOS Technologies, Inc.
Tucson, AZ USA

THIS DOCUMENT & ENCLOSED INFORMATION
REMAINS THE PROPERTY OF EOS
TECHNOLOGIES INC. INTELLECTUAL
PROPERTY AND INFORMATION HEREIN MAY
NOT BE COPIED NOR DISCLOSED WITHOUT
WRITTEN CONSENT OF EOS TECHNOLOGIES,
INC. MANAGEMENT.

FILE C:\GGay\Lick Schematics\SCH-5376-4 APF Cabinet Cable Schematics TEMP\m3limW023.SCHDOC
PRINTED 12/8/2009 4:07:56 PM
TEMPLATE: Eost_tabloid_SUBS

EOS Technologies, Inc.

3160 E. TRANSCON WAY, Suite 180
TUCSON, ARIZONA 85706 USA

TITLE

APF M3 Rotator Limits

DOCUMENT NUMBER

SCH-5376-4

SIZE

A3

EastConfig

SCH-5376-4

SHEET 31

OF 64

MONITOR EXTENSION CABLE

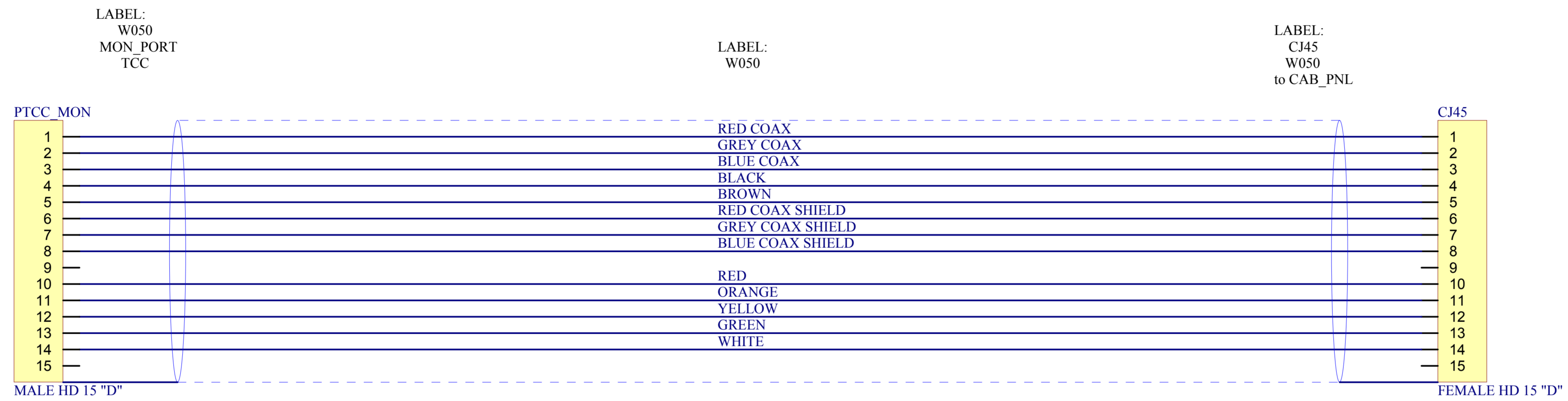

LENGTH: 48"
 WIRE TYPE: OTS MONITOR CABLE

© 2005 EOS Technologies, Inc.
 Tucson, AZ USA

THIS DOCUMENT & ENCLOSED INFORMATION
 REMAINS THE PROPERTY OF EOS
 TECHNOLOGIES INC. INTELLECTUAL
 PROPERTY AND INFORMATION HEREIN MAY
 NOT BE COPIED NOR DISCLOSED WITHOUT
 WRITTEN CONSENT OF EOS TECHNOLOGIES,
 INC. MANAGEMENT.

FILE C:\GGay\Lick Schematics\SCH-5376-4 APF Cabinet Cable Schematics TEMP\monW050.SCHDOC
 PRINTED 12/8/2009 4:07:57 PM
 TEMPLATE: Eost_tabloid_SUBS

EOS Technologies, Inc.
 3160 E. TRANSCON WAY, Suite 180
 TUCSON, ARIZONA 85706 USA

TITLE
APF Monitor Extension Cable

DOCUMENT NUMBER	SCH-5376-4	SIZE	A3
EastConfig	SCH-5376-4	SHEET 26 OF 64	

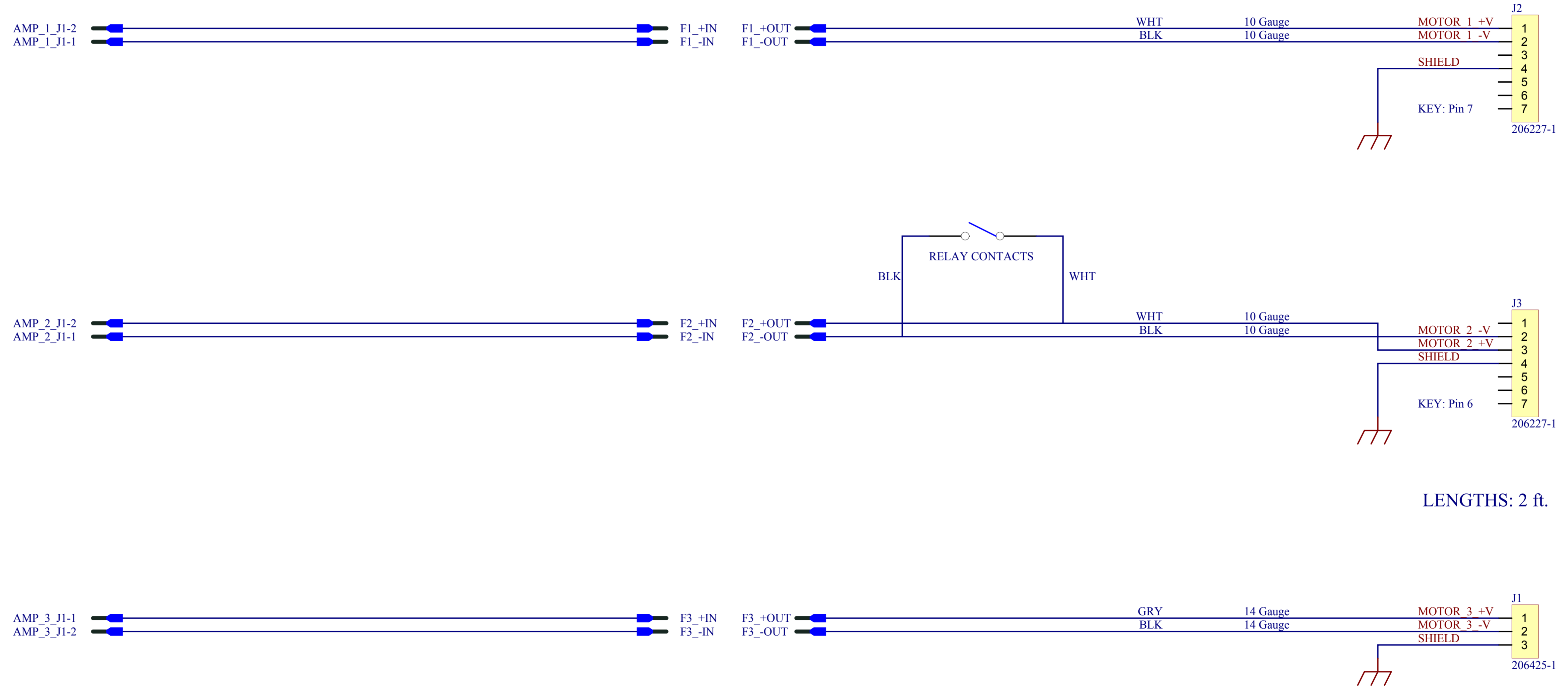

LENGTHS: 2 ft.

© 2005 EOS Technologies, Inc.
Tucson, AZ USA

THIS DOCUMENT & ENCLOSED INFORMATION
REMAINS THE PROPERTY OF EOS
TECHNOLOGIES INC. INTELLECTUAL
PROPERTY AND INFORMATION HEREIN MAY
NOT BE COPIED NOR DISCLOSED WITHOUT
WRITTEN CONSENT OF EOS TECHNOLOGIES,
INC. MANAGEMENT.

FILE C:\GGay\Lick Schematics\SCH-5376-4 APF Cabinet Cable Schematics TEMP\MOTOR_OUT_1.SCHDOC
PRINTED 12/8/2009 4:07:58 PM
TEMPLATE: Eost_tabloid_SUBS

EOS Technologies, Inc.

3160 E. TRANSCON WAY, Suite 180
TUCSON, ARIZONA 85706 USA

TITLE
LICK APF ENCP1 Motor Drive Outputs

DOCUMENT NUMBER
SCH-5376-4

SIZE
A3

EostConfig SCH-5376-4 SHEET 11 OF 64

SCH-5376-4 LICK APF ENCP1 Motor Drive Outputs

ENET EXTENSION CABLE

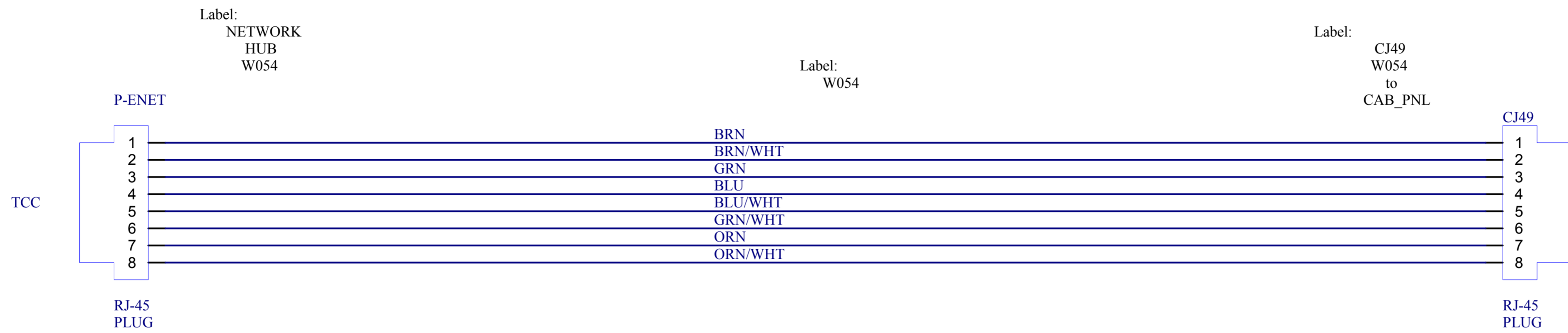

WIRE TYPE: NETWORK INTERFACE CABLE
 LENGTH: 38"

© 2005 EOS Technologies, Inc.
 Tucson, AZ USA

THIS DOCUMENT & ENCLOSED INFORMATION
 REMAINS THE PROPERTY OF EOS
 TECHNOLOGIES INC. INTELLECTUAL
 PROPERTY AND INFORMATION HEREIN MAY
 NOT BE COPIED NOR DISCLOSED WITHOUT
 WRITTEN CONSENT OF EOS TECHNOLOGIES,
 INC. MANAGEMENT.

FILE C:\GGay\Lick Schematics\SCH-5376-4 APF Cabinet Cable Schematics TEMP\netrkW054.SCHDOC
 PRINTED 12/8/2009 4:07:59 PM
 TEMPLATE: Eost_tabloid_SUBS

EOS Technologies, Inc.

3160 E. TRANSCON WAY, Suite 180
 TUCSON, ARIZONA 85706 USA

TITLE

APF Network Extension Cable

DOCUMENT NUMBER

SCH-5376-4

SIZE

A3

EastConfig

SCH-5376-4

SHEET 28

OF 64

OBSERVATORY DIGITAL INPUT AND OUTPUTS

Label:
P10_DIOP
W060
to J10_DIOP
CARD

Label:
W060

Label:
CJ11
W060
to CAB_PNL

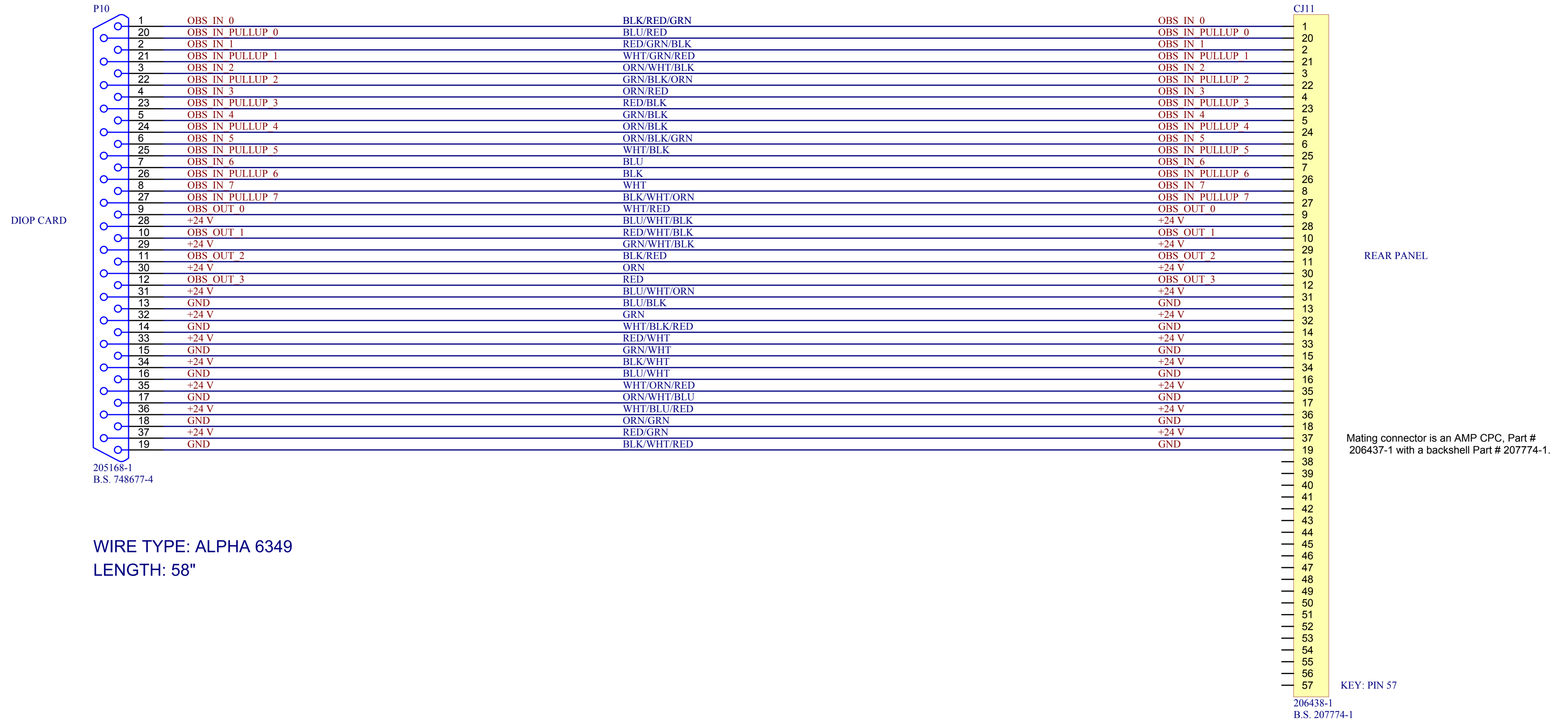

© 2005 EOS Technologies, Inc.
Tucson, AZ USA

THIS DOCUMENT & ENCLOSED INFORMATION
REMAINS THE PROPERTY OF EOS
TECHNOLOGIES INC. INTELLECTUAL
PROPERTY AND INFORMATION HEREIN MAY
NOT BE COPIED NOR DISCLOSED WITHOUT
WRITTEN CONSENT OF EOS TECHNOLOGIES,
INC. MANAGEMENT.

FILE C:\GGay\Lick Schematics\SCH-5376-4 APF Cabinet Cable Schematics TEMP\ObsDIO_W060.SchDoc
PRINTED 12/8/2009 4:07:59 PM
TEMPLATE: Eost_tabloid_SUBS

EOS Technologies, Inc.

3160 E. TRANSCON WAY, Suite 180
TUCSON, ARIZONA 85706 USA

TITLE

APF Observatory Digital I/O

DOCUMENT NUMBER

SCH-5376-4

SIZE

A3

EastConfig SCH-5376-4

SHEET 64 OF 64

PMAC RS232 INTERFACE

LABEL:
P_SER_1
W059
to TCC_PMAC
PNL

TCC PMAC_J4 Interface

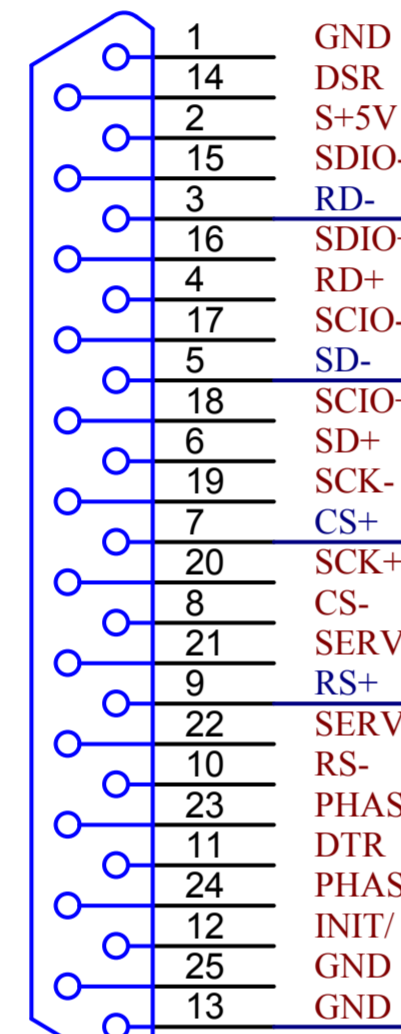

205166-1
B. S. 748677-3

LABEL:
W059

LABEL:
CJ59
W059
to
CAB PNL

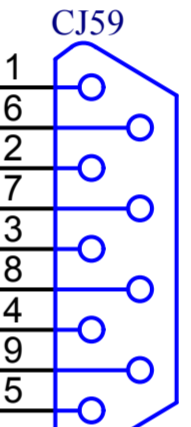

205161-2
B. S. 748677-1

LENGTHS: 32"
WIRE TYPE: Belden 1421A

© 2005 EOS Technologies, Inc.
Tucson, AZ USA

THIS DOCUMENT & ENCLOSED INFORMATION
REMAINS THE PROPERTY OF EOS
TECHNOLOGIES INC. INTELLECTUAL
PROPERTY AND INFORMATION HEREIN MAY
NOT BE COPIED NOR DISCLOSED WITHOUT
WRITTEN CONSENT OF EOS TECHNOLOGIES,
INC. MANAGEMENT.

FILE C:\GGay\Lick Schematics\SCH-5376-4 APF Cabinet Cable Schematics TEMP\PMAC serial W059.SchDoc
PRINTED 12/8/2009 4:08:00 PM
TEMPLATE: Eost_tabloid_SUBS

EOS Technologies, Inc.

3160 E. TRANSCON WAY, Suite 180
TUCSON, ARIZONA 85706 USA

TITLE

PMAC RS232 INTERFACE CABLE

DOCUMENT NUMBER

SCH-5376-4

SIZE

A3

EastConfig

SCH-5376-4

SHEET 63

OF 64

PMAC RS232 INTERFACE CABLE
SCH-5376-4

PMAC JMACHI CABLE

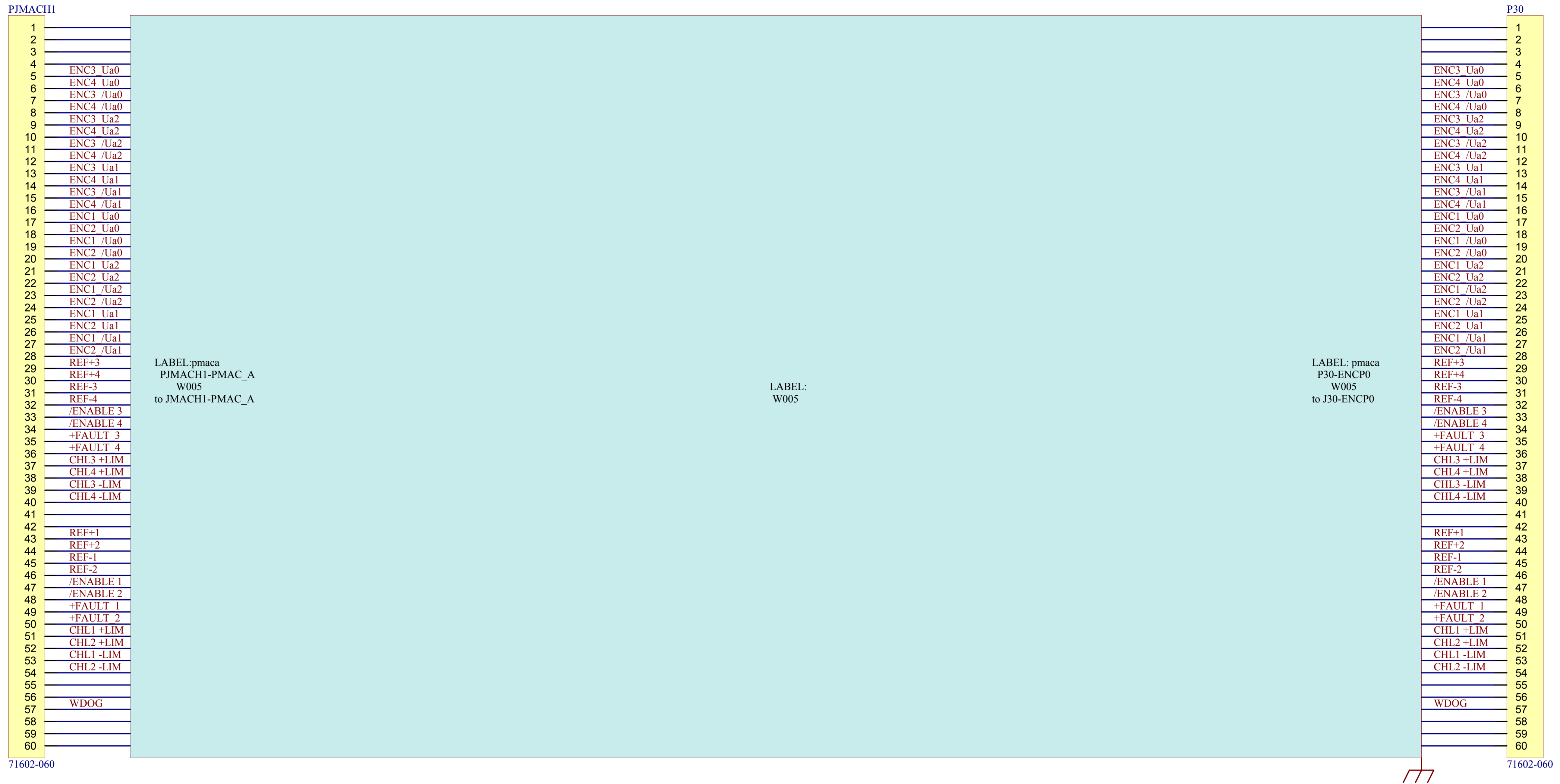

WIRE TYPE:843-159-2801-060 Shielded ribbon cable
 LENGTHS: PMACA: 31"

© 2005 EOS Technologies, Inc.
 Tucson, AZ USA

THIS DOCUMENT & ENCLOSED INFORMATION
 REMAINS THE PROPERTY OF EOS
 TECHNOLOGIES INC. INTELLECTUAL
 PROPERTY AND INFORMATION HEREIN MAY
 NOT BE COPIED NOR DISCLOSED WITHOUT
 WRITTEN CONSENT OF EOS TECHNOLOGIES,
 INC. MANAGEMENT.

FILE C:\GGay\Lick Schematics\SCH-5376-4 APF Cabinet Cable Schematics TEMP\pmacjmach1W005.SCHDOC
 PRINTED 12/8/2009 4:08:01 PM
 TEMPLATE: Eost_tabloid_SUBS

EOS Technologies, Inc.

3160 E. TRANSCON WAY, Suite 180
 TUCSON, ARIZONA 85706 USA

TITLE

LICK APF PMAC MACH1 to ENCP0 Interface

DOCUMENT NUMBER

SCH-5376-4

SIZE

A3

EastConfig SCH-5376-4

SHEET 18 OF 64

PMAC JMACH2 CABLE

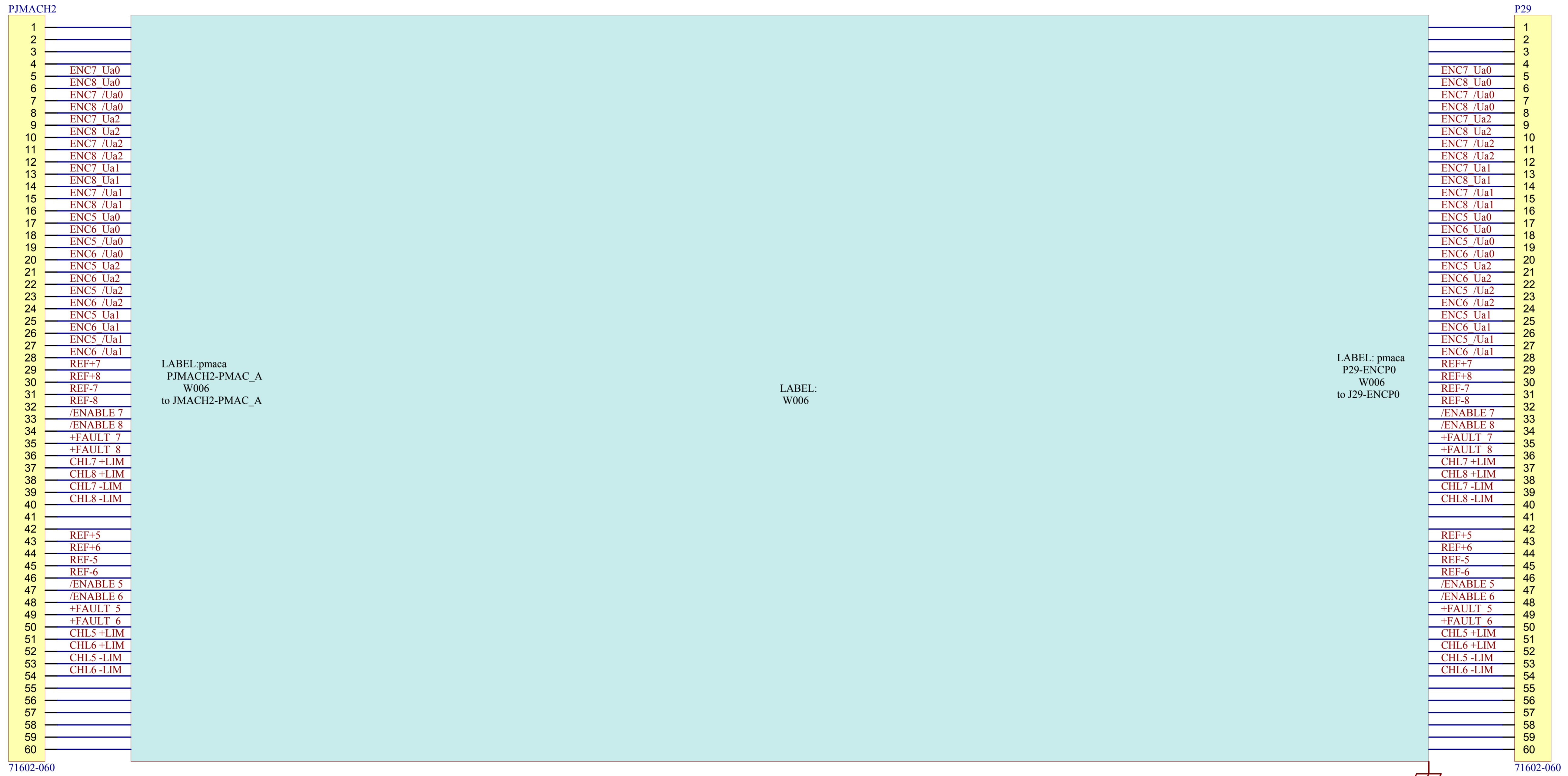

WIRE TYPE:843-159-2801-060 Shielded ribbon cable
 LENGTHS: PMACA: 36"

© 2005 EOS Technologies, Inc.
 Tucson, AZ USA

THIS DOCUMENT & ENCLOSED INFORMATION
 REMAINS THE PROPERTY OF EOS
 TECHNOLOGIES INC. INTELLECTUAL
 PROPERTY AND INFORMATION HEREIN MAY
 NOT BE COPIED NOR DISCLOSED WITHOUT
 WRITTEN CONSENT OF EOS TECHNOLOGIES,
 INC. MANAGEMENT.

FILE C:\GGay\Lick Schematics\SCH-5376-4 APF Cabinet Cable Schematics TEMP\pmacjmach2W006.SCHDOC
 PRINTED 12/8/2009 4:08:02 PM
 TEMPLATE: Eost_tabloid_SUBS

EOS Technologies, Inc.
 3160 E. TRANSCON WAY, Suite 180
 TUCSON, ARIZONA 85706 USA

TITLE
LICK APF PMAC MACH2 to ENCP0 Interface

DOCUMENT NUMBER	SIZE
SCH-5376-4	A3
EastConfig SCH-5376-4	SHEET 19 OF 64

SCH-5376-4 LICK APF PMAC MACH2 to ENCP0 Interface

THERMAL MONITOR POWER CABLE

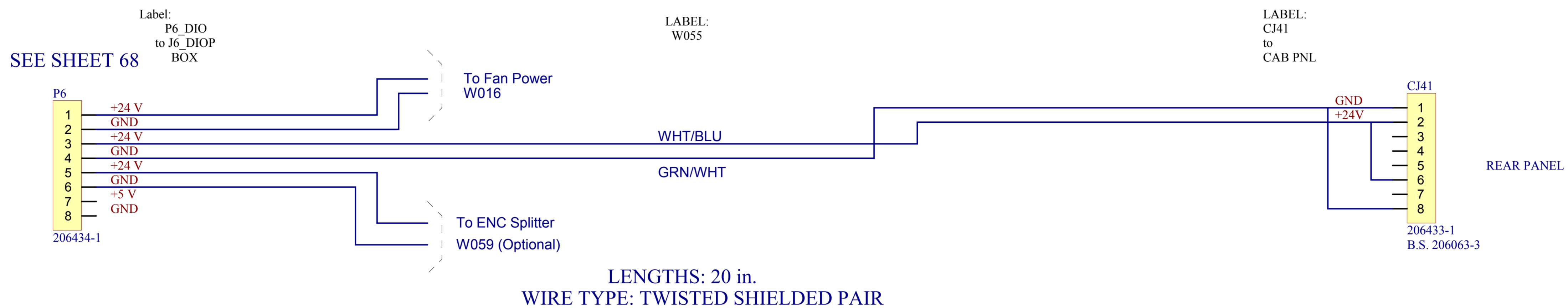

© 2005 EOS Technologies, Inc.
Tucson, AZ USA

THIS DOCUMENT & ENCLOSED INFORMATION
REMAINS THE PROPERTY OF EOS
TECHNOLOGIES INC. INTELLECTUAL
PROPERTY AND INFORMATION HEREIN MAY
NOT BE COPIED NOR DISCLOSED WITHOUT
WRITTEN CONSENT OF EOS TECHNOLOGIES,
INC. MANAGEMENT.

FILE
PRINTED 12/8/2009 4:08:03 PM
TEMPLATE: Eost_tabloid_SUBS

EOS Technologies, Inc.

3160 E. TRANSCON WAY, Suite 180
TUCSON, ARIZONA 85706 USA

CHANGE

APF Temperature Sensor Power Cable

DOCUMENT NUMBER

SCH-5376-4

SIZE

A3

EostConfig SCH-5376-4

SHEET 61 OF 64

TIME INPUT TO ENCP_0 and TRUETIME

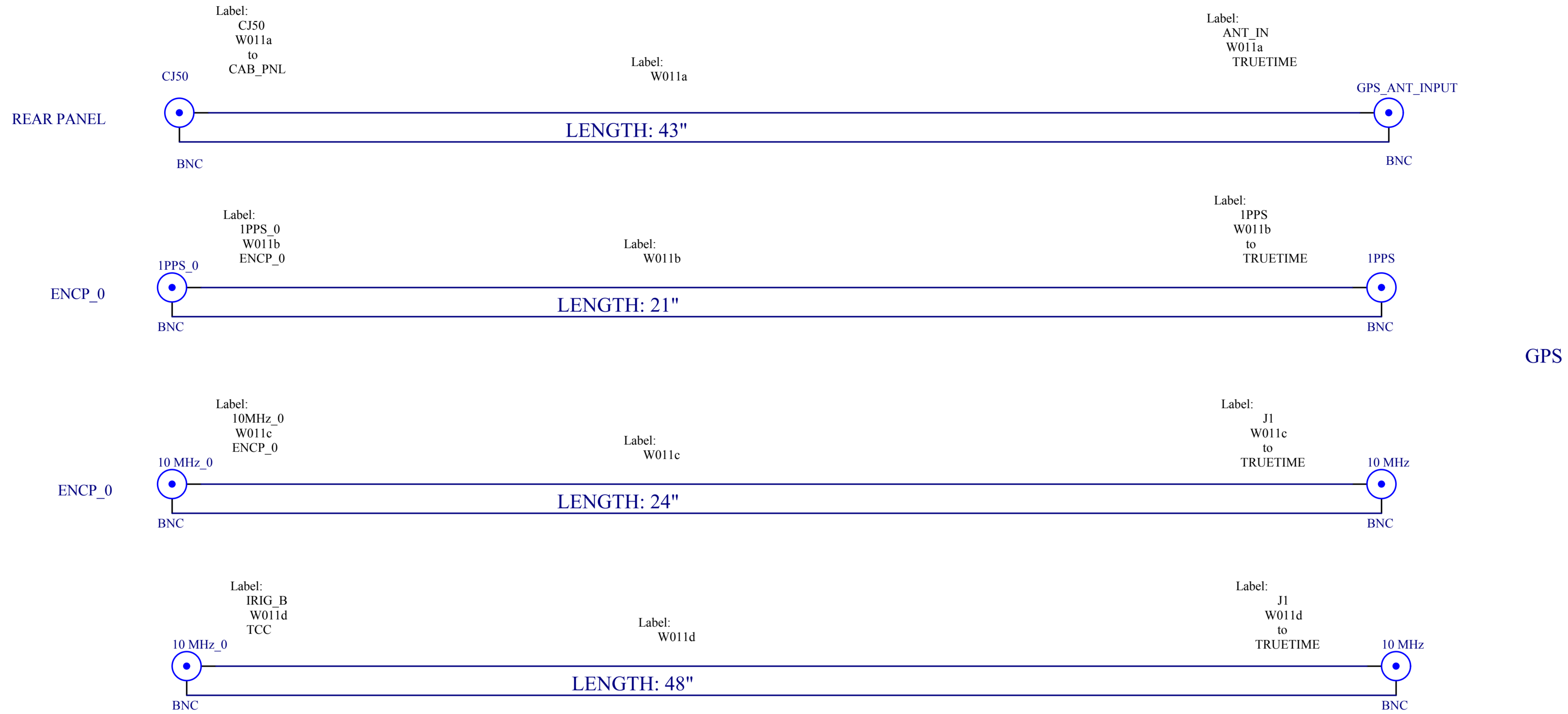

GPS

WIRE TYPE: ALPHA 9174

© 2005 EOS Technologies, Inc.
Tucson, AZ USA

THIS DOCUMENT & ENCLOSED INFORMATION
REMAINS THE PROPERTY OF EOS
TECHNOLOGIES INC. INTELLECTUAL
PROPERTY AND INFORMATION HEREIN MAY
NOT BE COPIED NOR DISCLOSED WITHOUT
WRITTEN CONSENT OF EOS TECHNOLOGIES,
INC. MANAGEMENT.

FILE C:\GGay\Lick Schematics\SCH-5376-4 APF Cabinet Cable Schematics TEMP\timeW011.SCHDOC
PRINTED 12/8/2009 4:08:04 PM
TEMPLATE: Eost_tabloid_SUBS

EOS Technologies, Inc.

3160 E. TRANSCON WAY, Suite 180
TUCSON, ARIZONA 85706 USA

TITLE

APF Observatory Timing Inputs

DOCUMENT NUMBER

SCH-5376-4

SIZE

A3

EastConfig SCH-5376-4

SHEET 29 OF 64